

**OFF-GRID RENEWABLE ENERGY OPTIONS
FOR RURAL ELECTRIFICATION IN WESTERN CHINA**

by the

**Center for Energy and Environmental Policy of
University of Delaware**

Sponsored by

National Renewable Energy Laboratory

and

**Ministry of Agriculture
People's Republic of China**

June 2001

**OFF-GRID RENEWABLE ENERGY OPTIONS FOR RENEWABLE
ELECTRIFICATION IN WESTERN CHINA**

Researchers:
Aiming Zhou
Jihong Zhao
Takuo Yamaguchi
Jessie Manuta
William James Smith, Jr
Govind Gopakumar
Subid Wagley
Christopher Linn
Johanna Gregory
Kenneth Wicker
Venkatesh R. Iyer

Research supervised by:
John Byrne, Director
Young-Doo Wang, Associate Director
Bo Shen, Policy Fellow
Center for Energy and Environmental Policy
University of Delaware
Newark, Delaware 19716-7387

Sponsored by
National Renewable Energy Laboratory
and
Ministry of Agriculture
People's Republic of China

June 2001

PREFACE

It is a pleasure to provide the National Renewable Energy Laboratory (NREL) with this report. Prepared in accordance with special tasks in the US – China Energy Efficiency and Renewable Energy Protocol, the report offers an in-depth feasibility analysis of off-grid renewable energy systems and a comprehensive socio-economic assessment of renewable energy utilization in Western China. The Center for Energy and Environmental Policy (CEEP) is solely responsible for the findings and recommendations of the report.

The cooperation and advice of China's Ministry of Agriculture, the Chinese Academy of Science — Institute of Policy Management, and the Center for Renewable Energy Development (CRED) are much appreciated.

I hope the report is useful for continued research and study in the field of renewable energy utilization in rural areas.

John Byrne
Director, CEEP

TABLE OF CONTENTS

PREFACE	
TABLE OF CONTENTS	
LIST OF TABLES	
LIST OF FIGURES	
ABBREVIATIONS AND ACRONYMS	
EXECUTIVE SUMMARY	I
Background	i
Major Results and Recommendations	iii
1. INTRODUCTION.....	1
1.1 Background	1
1.2 Objectives	2
1.3 Methodology	2
1.4 Renewable Energy and Rural Electrification: A Conceptual Understanding.....	3
2. PROFILE OF WESTERN CHINA	5
2.1 Inner Mongolia Autonomous Region	7
2.2 Qinghai Province	9
2.3 Xinjiang Uygur Autonomous Region	9
3. ECONOMICS OF STAND-ALONE RENEWABLE ENERGY SYSTEMS	11
3.1 Stand-Alone Renewable Energy Systems.....	11
3.2 An Overview of RREAD	12
3.3 Energy Analysis	16
3.3.1 Sizing of Renewable Energy Systems	16
3.3.2 Energy Output of Renewable Energy Systems.....	19
3.3.3 Reliability of Renewable Energy Systems	20
3.3.4 Evaluation of Competing Engine Generator Systems	22
3.3.5 Social and Environmental Factors Beyond the Energy Analysis	24
3.4 Economic Analysis	25
3.4.1 Preparation of the Cost Stream and Estimation of NPV.....	25
3.4.2 Calculation of Levelized Energy Costs	26
3.4.3 Social and Environmental Factors Beyond Conventional Economic Analysis.....	27
3.5 Sensitivity Analysis	28
3.5.1 Impacts of Technological Improvements and Market Development on Renewable Energy Use	28
3.5.2 Impacts of Policy Interventions.....	29
3.6 Summary	29
4. ECONOMICS OF STAND-ALONE RENEWABLE ENERGY SYSTEMS IN WESTERN CHINA	31
4.1 Resource Evaluation for IMAR, Qinghai, and Xinjiang.....	31
4.2 Levelized Cost Analysis	32

5. MODELING OF SOCIO-ECONOMIC ASSESSMENT OF OFF-GRID RENEWABLE USERS	45
5.1 Overview of the Socio-Economic Assessment Study.....	45
5.2 Rural Renewable Energy Survey	46
5.2.1 Survey Questionnaire	46
5.2.2 Sampling Design	47
5.3 Data Preparation.....	48
5.4 Descriptive and Comparative Statistics	50
5.4.1 General Household Characteristics	50
5.4.2 Household Electricity Uses and Energy Systems.....	51
5.5 Socio-Economic Conditions Affecting Attitudes Toward Renewable Energy.....	53
5.6 Conclusion	54
6. MARKET POTENTIAL AND SIZE OF RURAL RENEWABLE ENERGY SYSTEMS IN WESTERN CHINA	57
6.1 Creation of a Logistic Regression Model	57
6.2 Logistical Regression Modeling for the Determination of Key Predictors of Rural Renewable Energy Purchasers.....	59
6.2.1 Variables for Modeling.....	59
Representation.....	59
Representation.....	61
6.2.2 Model Building.....	62
6.2.3 Modeling Results.....	63
6.3 Results of Logistical Regression Analysis.....	71
6.4 Statistical Robustness of the Model.....	72
6.5 Prediction of the Potential Size of the Renewable Energy Market in Western China	73
6.6 Future Rural Renewable Energy Market Potentials in IMAR, Qinghai and Xinjiang	74
Conclusion	76
7. POLICY OPTIONS FOR STIMULATING COMMERCIALIZATION OF RENEWABLE ENERGY IN WESTERN CHINA	79
7.1 Building An Institutional Framework.....	79
7.2 Investing in Renewable Energy	80
7.3 Increasing Financial Support	81
7.4 Utilization of Renewable Energy Improving Services and Training for the Technologies.....	82
7.5 Global Cooperation.....	83
7.6 Conclusion	83
APPENDIX A: DESCRIPTION OF DATA REQUIRED TO RUN THE RURAL RENEWABLE ENERGY ANALYSIS AND DESIGN (RREAD).....	87
APPENDIX B: HOUSEHOLD SURVEY TEMPLATE FOR RURAL ENERGY USE IN WESTERN CHINA	91

APPENDIX C: TEMPLATE FOR SOCIO-ECONOMIC ASSESSMENT SURVEY AT
COUNTY AND PROVINCIAL LEVEL IN WESTERN CHINA 103

LIST OF TABLES

Table 2-1: Rural Households Without Electricity in China, 1997	6
Table 4-1: Wind and Solar Energy Resources in Western China	32
Table 4-2: Assumptions and Parameters Used in the Analysis of Household Systems....	34
Table 4-3: Levelized Costs for PV, Wind and Hybrid Systems in IMAR	34
Table 4-4: Levelized Costs for PV, Wind and Hybrid Systems in Xinjiang	35
Table 4-5: Levelized Costs for PV, Wind and Hybrid Systems in Qinghai	35
Table 5-1: Summary of Sampling Design.....	48
Table 5-2: IMAR, Qinghai and Xinjiang Household Profile	51
Table 5-3: Distribution of Generation Systems by Province	52
Table 5-4: PV System Profiles	52
Table 5-5: Wind System Profiles	53
Table 6-1: Response Variables.....	59
Table 6-2: Explanatory Variables	61
Table 6-3: Analysis of Maximum Likelihood Estimates :Wind Users	63
Table 6-4: Analysis of Maximum Likelihood Estimates :PV Users	65
Table 6-5: Analysis of Maximum Likelihood Estimates :Hybrid Users.....	67
Table 6-6: Analysis of Maximum Likelihood Estimates :Large System Users.....	68
Table 6-7: Maximum Likelihood Estimates.....	70
(Willingness to Seek a loan to purchase a Large System with Loan)	70
Table 6-8 : Analysis of WestERN China Market potential: Willingness to Own and Pay for Renewable Energy Systems.....	74
Table 6-9: Market Size of Renewable Energy System in IMAR, Xinjiang and Qinghai ..	76
Table 6-10: Market Size Estimation of PV System in IMAR, Xinjiang and Qinghai By World Bank	76

LIST OF FIGURES

Figure 2-1: Annual Net Income per Capita of Rural Households in Three Provinces from 1978 to 1997.....	6
Figure 2-2: Net income per capita in IMAR	8
Figure 3-1: Conceptual Drawing of a Stand-Alone Hybrid Renewable Energy System ..	12
Figure 3-2: Overall Structure of RREAD	14
Figure 3-3: Logical Flow Chart of RREAD.....	15
Figure 4-1: Levelized Costs for PV, Wind, Gasoline Gen-Set and Hybrid Systems in Selected Counties in IMAR, China.....	37
Figure 4-2: Levelized Cost Analysis for PV, Wind and Hybrids in Tuokxun, Xinjiang, China	37
Figure 4-3: Levelized Cost Analysis for PV, Wind and Hybrids in Mengyuan, Qinghai, China	38
Figure 4-4: Wind Resource Distribution (Wind Speed ≥ 4 m/s).....	41
Figure 4-5: Wind Resource Distribution (Wind Speed ≥ 6 m/s).....	43
in Qinghai, Xinjiang and IMAR, China	43
Figure 4-6: Solar Resource Distribution in Qinghai, Xinjiang and IMAR, China.....	43
Figure 4-7: Total Average Levelized Cost Distribution and the System with the Lowest Levelized Cost for Specific Counties in Qinghai, Xinjiang and IMAR, China	44
Figure 5-1: Conceptual Framework of Socio-Economic Assessment Study	46
Figure 5-2: Diagram The Sampling Design Used for the Household Survey.....	47
Figure 5-3: Education Level of Household Members.....	50

ABBREVIATIONS AND ACRONYMS

AC	Alternating Current
BOS	Balance-Of-System
CAMS	Chinese Academy of Meteorological Science
CEEP	Center for Energy and Environmental Policy
CRED	Center for Renewable Energy Development
DC	Direct Current
DOD	Depth of Discharge
DSM	Demand Side Management
EOR	Estimated Odds Ratio
IMAR	Inner Mongolia Autonomous Region
LRM	Logistic Regression Model
MEP	Ministry of Electric Power
NPV	Net Present Value
NREL	National Renewable Energy Laboratory
O&M	Operating and Maintenance
POA	Plane of Array
REEZ	Renewable Energy Enterprise Zones
REHH	Renewable Energy Household
RERF	Rural Renewable Energy Revolving Funds
RREAD	Rural Renewable Energy Analysis and Design
SHS	Solar Home System
TMY	Typical Meteorological Year
UEHH	Un electrified Household

EXECUTIVE SUMMARY

Background

During the past twenty years, China has provided hundreds of millions of rural people with access to electricity (China Electric Power Yearbook, 1996). The major approaches to rural electrification have been the extension of power grids and the exploitation of small hydropower or micro-hydro. Despite these accomplishments, over 60 million people living in rural China, one-fifth of whom are in Western China, still have no access to electricity (China Electric Power Yearbook, 1996). Due to the prohibitive cost of extending grid services and the lack of hydropower resources in these remote locations, exploring appropriate ways to provide electricity to these communities has been a key issue for the Chinese government. Under bilateral agreements between the U.S. Department of Energy and the Chinese Ministry of Science and Technology (the U.S-China Energy Efficiency and Renewable Energy Protocol), the National Renewable Energy Laboratory (NREL) and the Center for Energy and Environmental Policy (CEEP) at the University of Delaware have conducted a four-year research project examining off-grid renewable energy options for rural electrification in Western China.

The present project expands the methodology and software developed at CEEP for resource and economic analysis of rural renewable energy applications. The regional unit of analysis is the three-province area of the Inner Mongolia Autonomous Region, Qinghai Province and the Xinjiang Uygur Autonomous Region. An assessment of market potential and size for small wind (turbines with capacities less than 300 W) and small PV (array capacity less than 120 Wp) was carried out in two phases. The first phase was an analysis of the economics of off-grid renewable energy systems to be operated in rural villages in Western China. The aims of the economic analysis were:

- (1) to assess the wind and solar energy resource potential in Western China;

- (2) to develop a comprehensive analytical tool that can be utilized to evaluate the energy capability and economic viability of off-grid wind and photovoltaic (PV) technologies in providing electricity services to remote rural households;
- (3) to compare system performance of different stand-alone PV and wind configurations (i.e., PV-only, wind-only and hybrid technologies) and competing choices (renewables versus gen-set options); and
- (4) to determine the cost-effectiveness of different system configurations and technology options by calculating system levelized costs.

The second phase of this project involved conducting a comprehensive socio-economic assessment of renewable energy utilization in Western China. The goals of this assessment were:

- (1) to characterize rural energy user needs and preferences;
- (2) to understand the socio-economic conditions that affect the use of renewable energy options in Western China;
- (3) to evaluate the market potential and size for renewable energy systems in these regions; and
- (4) to develop policy recommendations for the development of Western China's renewable energy market.

The following tools were constructed to realize the goals of this project. To carry out the economic analysis, a spreadsheet-based computer simulation model, the Rural Renewable Energy Analysis and Design Tool (RREAD), was created to evaluate the energy and economic performance of off-grid renewable energy technologies including PV, wind and PV/wind hybrid systems in comparison with conventional gasoline or diesel generators. RREAD was employed to examine the resource potential and economics of a wide variety of household scale PV systems (ranging from 22W_p to 120W_p), wind turbines (100 to 300W) and PV/wind hybrid systems (300W wind turbine with 35-60W_p PV for small hybrids and 100-120W_p for larger hybrids).

To conduct the socio-economic assessment of renewable energy utilization in Inner Mongolia, Qinghai, and Xinjiang, a household survey and sampling methodology were created. Working closely with Chinese research partners, a total of 531 rural households in 22 counties were surveyed to characterize rural energy users in the investigated regions. The household survey data, combined with socio-economic information at county and regional levels, were then evaluated through a statistical method involving dichotomous dependent variable – logit regression – to identify the social, economic and technical factors that affect the choice of renewable energy options among rural families in Western China. Based on the sample data, we created market choice models and identified key predictors for the purpose of forecasting market potential and size of off-grid renewable energy systems in Western China.

Major Results and Recommendations

We conclude that making full use of indigenous wind and solar resources can be the most economical and practical way to provide electricity access to rural unelectrified households in Western China. The current socio-economic conditions in this region have already spawned a substantial market for wind, PV and hybrid power systems. However, to fully serve this market, significant economic and institutional barriers must be overcome. The following is a summary of the major conclusions and recommendations of this report.

- Our resource evaluation shows that in the investigated region, most counties have rich wind and/or solar resources. Xinjiang has the best solar resource in the region, while Inner Mongolia has the best wind resource. Qinghai has high solar radiation and a significant number of sunshine hours. In Inner Mongolia, wind and solar resources are complementary, so a stable annual electricity supply can be obtained through hybrid systems. While less geographically extensive, complementary solar-wind resource opportunities also exist in Qinghai and Xinjiang. Chapter 4 provides a detailed description of our resources assessment.

- Detailed levelized cost analyses of comparable technologies reveals small wind, PV or wind/PV hybrid systems, are more economical than typical fossil fuel options available to rural communities in the three-province regions (i.e., diesel or gasoline generators in the off-grid rural areas in IMAR, see Chapter 4).
- Analysis of existing and potential markets shows that the three-province region has substantial potential for stimulating a renewable energy market. Specifically it appears that market with sales of \$ 21.24 billions is feasible. Chapters 5 and 6 describe the analysis conducted by researchers at CEEP on market potential and size.
- Although we demonstrate that reliable and economic renewable energy applications can address rural electricity needs in Western China, significant barriers prevent full commercialization of decentralized renewable energy technologies. These barriers, ranging from high initial costs to a lack of capital resources and unfavorable institutional arrangements, have prevented the realization of the full potential of renewable energy in Western China. To eliminate these barriers and to take full advantage of the opportunities identified by this report, policies and institutional strategies designed specifically for rural renewable energy development will be required. The policy proposals we offer include:
 - ◆ Building an institutional framework that promotes renewable energy
 - ◆ Increasing financial support for renewable energy
 - ◆ Creating renewable energy information systems to support market development
 - ◆ Improving services and training for the utilization of renewable energy technologies
 - ◆ Promoting international cooperation to diffuse appropriate scale, affordable and reliable renewable energy technologies for rural users in Western China.

Chapter 7 contains detailed policy proposals made by this report as a result of our research.

1. INTRODUCTION

1.1 Background

Since the 1970s, China has dramatically expanded its power supply, including service to rural areas. As a result of this expansion, the country has made significant progress in providing individuals in rural areas with a reliable supply of electricity. Despite this great accomplishment, over 60 million people living in rural China still have no access to electricity (MEP,1996). Approximately one-fifth of this population is located in the IMAR, Qinghai Province and the Xinjiang. Because of the prohibitive cost of extending grid services to remote locations, many people living in the western part of the country continue to depend on wood or diesel/gasoline generators for their daily energy needs. This region of the country has low population density as well as a high percentage of minority inhabitants with low incomes. In fact, the great majority of the inhabitants in this area of the country live below the national poverty level (China Rural Areas Poverty-Alleviation Investigation Report, 1999). In addition, a significant environmental problem has arisen from the combustion of fossil fuels to spur economic growth (Yan, 1996). Importantly, though, this area of China also possesses rich solar and wind resources.

In order to explore the feasibility of providing reliable electricity services to rural populations in Western China using renewable energy, the U.S. Department of Energy and the Chinese Ministry of Science and Technology undertook a bilateral agreement for research and market development. Under the agreement (entitled the “U.S.-China Energy Efficiency and Renewable Energy Protocol”), the National Renewable Energy Laboratory (NREL) and the Center for Energy and Environmental Policy (CEEP) at the University of Delaware have conducted research in conjunction with the Institute of Policy and Management of the Chinese Academy of Sciences, the Institute of Energy and Environmental Research of China's Ministry of Agriculture, the New Energy Office of China's Inner Mongolia Autonomous Region Government and the Center for Renewable Energy Development. This four-year research project has produced a comprehensive set of policy recommendations for the Chinese government to undertake in order to promote renewable rural electrification in Western China.

1.2 Objectives

This research project has been carried out in two phases. The first has been a feasibility study involving an assessment of resource availability and the economics of off-grid renewable energy systems in three of China's provinces/autonomous regions—Inner Mongolia, Qinghai and Xinjiang. The objectives of the feasibility study were: (1) to develop a comprehensive analytical tool that would be utilized to evaluate the energy capability and economic viability of off-grid wind and photovoltaic (PV) technologies in providing electricity services to remote rural households; (2) to assess renewable energy resource potential in these regions; (3) to compare system performance of different configurations (i.e., single vs. hybrid technologies) and competing choices (renewable vs. gen-set options); and (4) to determine the cost-effectiveness of different system configurations and technology options by calculating system levelized costs.

The second phase of this project has been a comprehensive socio-economic assessment of renewable energy utilization in Western China. The goals of this assessment were: (1) to characterize the needs and preferences of rural energy users; (2) to understand the socio-economic conditions that affect the use of renewable energy options in Western China; (3) to predict the market potential and size for renewable energy systems in these regions; and (4) to devise policy recommendations for the development of Western China's renewable energy market.

1.3 Methodology

In order to evaluate solar and wind resource availability and the economic feasibility of renewable energy options, CEEP constructed a spreadsheet-based computer simulation model called Rural Renewable Energy Analysis and Design Tool (RREAD). This tool evaluates the energy and economic performance of off-grid renewable energy technologies including PV, wind and PV/wind hybrid systems in comparison with conventional gasoline or diesel generators (John Byrne, Bo Shen and William Wallace , 1998). CEEP employed RREAD to examine the economics of a wide variety of household scale PV systems (ranging from 22Wp to 120Wp), wind turbines (100 to

300W) and PV/wind hybrid systems (300W wind turbine with 35-60Wp PV for small hybrids and 100-120Wp of PV for larger hybrids).

To conduct the socio-economic assessment of renewable energy utilization in Inner Mongolia, Qinghai, and Xinjiang, CEEP designed a comprehensive survey questionnaire and a survey sampling design statistically representing the variety of rural energy users found in Western China. Working closely with its Chinese research partners, CEEP surveyed a total of 531 rural households spread over twenty-two counties throughout Western China to characterize rural energy users in the investigated regions. This household survey data, combined with socio-economic information at county and regional levels, was then evaluated by means of statistical analysis for the identification of social, economic and technical factors that affect the use of renewable energy options in these areas. Based on the sample data, members of the research team created logit regression models and identified key predictors for the purpose of predicting the market potential of off-grid renewable energy systems in Western China.

1.4 Renewable Energy and Rural Electrification: A Conceptual Understanding

In China's case, their sustainable development policy plan — titled *China Agenda 21* (China Environment Science Press, 1994) – suggests that the country needs to significantly increase its use of renewable energy resources if its goals of economic, energy and environmental sustainability are to be realized. This report can play an assistive role in alleviating rural poverty and in minimizing poverty-induced environmental degradation throughout rural China.

Since renewable energy is a promising alternative to help China in achieving their long-term goal of sustainable rural development, this project points out various levels of renewable energy options to accomplish this goal. This report emphasizes the importance of following an alternative energy path to promote development that is both sustainable and equitable. At the same time, this study highlights the current unsustainable character of rural development, with particular emphasis on the contradictions in rural energy uses. The failure of the current development path demonstrates the need for a new model that

embraces renewable energy resources to satisfy the distinctive needs of rural communities and agricultural economies in China. The study also stresses the economic, social and environmental benefits of using renewable energy resources in rural areas. This report is the culmination of four years of exhaustive research on behalf of the organizations involved with CEEP in executing certain tasks in the U.S.-China Energy Efficiency and Renewable Energy Protocol.

2. PROFILE OF WESTERN CHINA

The potential target markets for solar PV, wind turbine and hybrid systems are made up of two main groups: (a) individual households and businesses in areas not currently electrified or scheduled for grid service in the next five years; and (b) individual households and businesses in areas that have only seasonal or restricted electricity supply (e.g., supplied by small hydro for six months).

Individual households and businesses in areas without electrical service. There are 858,485 households in Inner Mongolia, Qinghai and Xinjiang provinces that do not have a reliable power supply (China Electric Power Yearbook, 1997). These households include herdsmen, farming families and those with rural commercial businesses. Care was taken to exclude from this analysis, households that will be electrified during the next five years since rural electrification is progressing rapidly. The official government goal had been to provide electrical services to 100% of the rural households by the year 2000. Despite a great effort by provincial governments, this target was not reached.

Table 2-1 explains why the provinces of Inner Mongolia, Qinghai, Xinjiang were selected for the project. They have a large population of dispersed households that are difficult to serve with electricity by any means other than renewables. Some of these households have sheep herding businesses, giving them higher incomes on average than farmers. They are ideal candidates for hybrid renewable energy systems as they may be able to afford the capital cost of such technologies.

Individual households and commercial establishments in areas with inadequate electrical service. Potential markets also include rural households and businesses with inadequate energy supply. These areas are served by small hydro, which often provides power for only 50-75 per cent of the year¹. However, data sources for estimating the number of these households are not available.

¹ The small hydro resource in Qinghai is not good because Qinghai Province locates on the plateau of Northwest highland, there is little small hydro resources, in Xinjiang, there is small hydro resources under the foot of Tianshan Mountain, however, those small hydro resource are not overlap with the area we

TABLE 2-1: RURAL HOUSEHOLDS WITHOUT ELECTRICITY IN CHINA, 1997

	Total Rural Households in 1996	Rural Households without Electricity in 1996
Inner Mongolia	4,807,977	348,618
Xinjiang	3,157,602	407,685
Qinghai	649,853	100,186
Total	8,617,428	858,485

Source: China Electric Power Yearbook, 1997

FIGURE 2-1: ANNUAL NET INCOME PER CAPITA OF RURAL HOUSEHOLDS IN THREE PROVINCES FROM 1978 TO 1997

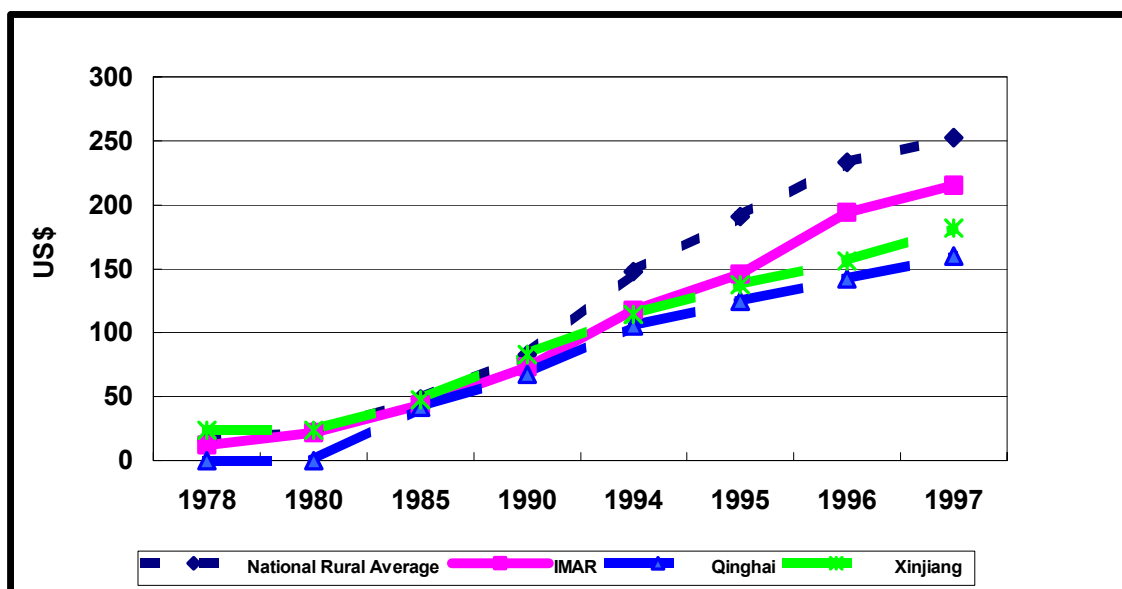

Source: Statistical Yearbook of China 1997, Beijing: China Statistical Publishing House.

studied in this project. For Inner Mongolia, there is little small hydro resources. The exploitable small hydro resource in three regions/province are: 2000.0 MW in Qinghai, 3979.0 MW in Xinjiang and 387.0 MW in Inner Mongolia. (Source: Tong, Jiandong, *China Small Hydro*, International Network on Small Hydro Power, 1998)

Rural living income in Inner Mongolia Autonomous Region (IMAR) is the highest among the three provinces followed by Xinjiang and then Qinghai (Figure 2-1). This is primarily due to the relatively higher income from sheep ranching prevalent in the IMAR versus crop farming in the other provinces.

2.1 Inner Mongolia Autonomous Region

The Inner Mongolia Autonomous Region (IMAR) of northwestern China was the first national autonomous region established in China. It is one of China's largest administrative regions, with a total area of about 1.183 million km², or one-eighth of the country's total land area (Inner Mongolia Statistical Yearbook, 1999). Much of Inner Mongolia is a high, inland plateau with elevations of about 1000 m. Inner Mongolia is home to the vast Gobi Desert and the Huang He (Yellow River). There are numerous settlements and several cities along the river's course. The region's climate is typically dry and continental, with warm summers and very cold, dry winters. Grasslands predominate on the plateau, where they sustain large numbers of grazing animals such as sheep, goats, camels, and horses.

The 1998 estimated population of Inner Mongolia was 23.45 million (Inner Mongolia Statistical Yearbook, 1999). Two-thirds of the population lives in rural areas. Traditionally, Inner Mongolia's economy has been agricultural, with animal husbandry and forest products, providing most of agricultural income. A few highways link Inner Mongolian cities with the rest of China and domestic air service links the larger cities with Beijing. However, much of Inner Mongolia remains isolated.

Inner Mongolia is one of the regions with the greatest commercial development potential for wind power in China. The region has abundant wind resources and significant demand for wind-generated power. The local government and power bureau have authorized several financial incentives to promote the development of wind power.

The net income per capita of rural herder and farming families in Inner Mongolia has steadily grown from 1978 to 1996 (Figure 2-2). From this figure, per capita annual

net income of farmers and herdsmen in IMAR in 1996 was about \$194, and herder families in IMAR had higher net incomes per capita than farmers.

FIGURE 2-2: NET INCOME PER CAPITA IN IMAR

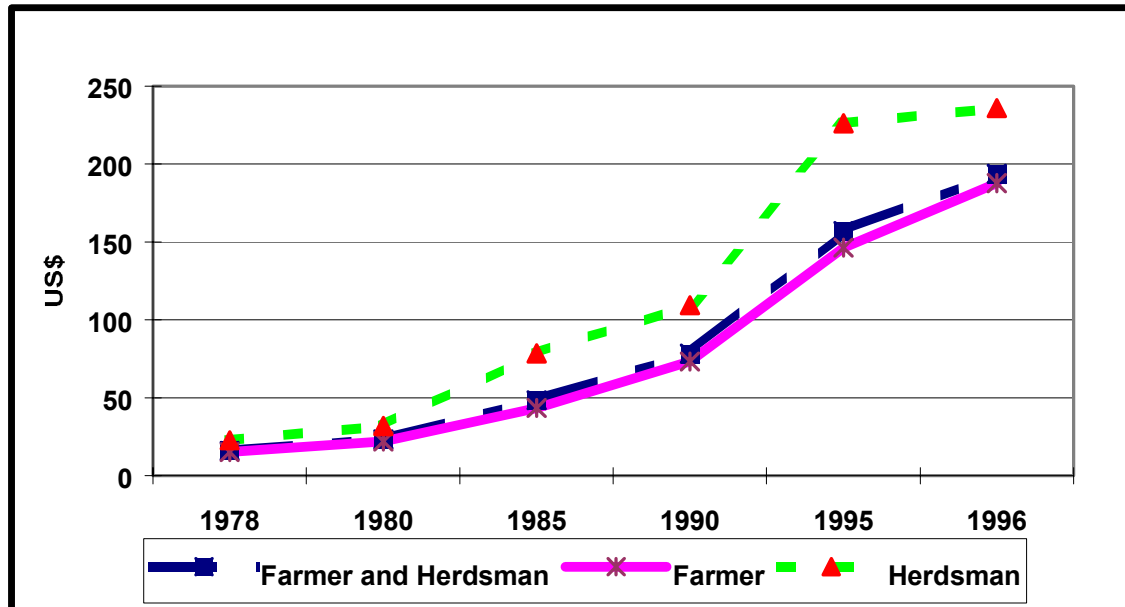

Source: Inner Mongolia Statistical Yearbook, 1997, Beijing: China Statistical Publishing House

In IMAR, on average, each rural household has 4 persons. This means that the net income of a family is about \$776, an amount sufficient for households without electricity to pay for PV, wind or hybrid systems. Consequently, the renewable energy market potential in IMAR is expected to be large.

According to researchers at the Chinese Academy of Meteorological Science (CAMS), both wind and solar resources in the IMAR are some of the richest in China (Zhu, 1988; see also He and Shi, 1995 and Yan, 1994). The CAMS study divides different regions throughout China into three resource potential categories: rich, marginal and poor. Based on the CAMS taxonomy, resources are rich in those areas with 150 W per m² of wind energy density and 1510 kWh per m² of annual solar insolation. Both wind and solar resources in the IMAR, despite large variations, are rich throughout the region, using the CAMS definition.

2.2 Qinghai Province

Located in China's western Qinghai-Tibetan Plateau, Qinghai Province covers one-thirteenth of the nation's land area (about 721,000 km²) and is one of China's least populated provinces, population in 1997 was about 4.96 million. (Qinghai Statistical Yearbook, 1998). The capital, Xining, is the only large city. Han Chinese (the majority in China) constitute only about one-third of the population; Mongols, Tibetans, Hui and Kazaks are the largest ethnic minorities. Qinghai (which means "Green Sea") is the source of both the Yellow and Yangtze rivers, and home to the country's largest salt-water lake, Qinghai Lake. The province houses vast grasslands, wildlife, bird sanctuaries, the Gobi desert and salt ponds. Qinghai's modern development began in the 1950s with the discovery of mineral resources and the construction of a rail line leading from Xining to the east. Coal, petroleum, and iron ore are the leading natural resources sold by the Province to domestic and international markets

There are more than 100,000 peasant and herding families in Qinghai without access to electricity. Province officials have initiated a program to alleviate poverty through the provision of power, which targets 70,000 of these families. The project aim to install 1.4 MW of solar home systems (SHSs) which are typically 20 Wp – 40 Wp in size; and a 340-kW centralized photovoltaic (PV) system is to be installed at the county or township level for several thousand small communities. There are two PV sales and service companies in Qinghai, which supply more than 80% of the market.

2.3 Xinjiang Uygur Autonomous Region

Xinjiang Uygur Autonomous Region is China's largest region, with a total area of about 1.647 million km², approximately one-sixth of China's total land area. The 1995 estimated population of Xinjiang was 16.6 million. Most cities in Xinjiang lie near the foot of mountains, strung along the ancient Silk Road route. Agriculture is the traditional economic base of Xinjiang, but new industries have recently developed to exploit available local resources, which include extensive oil, natural gas, and coal deposits. There has been rapid growth in cross-border trading in consumer and industrial goods

with the independent countries of Central Asia, created after the dissolution of the Union of Soviet Socialist Republics (USSR) in 1991. Needless to say, the very low population density of the region have prevented electrical grid service to one-fifth of the population.

In 1996, there were 8.76 million rural residents living in Xinjiang and over half lived in rural households. According to the *Rural Statistical Yearbook of China 1997*, the net income per capita for rural households was \$156, much lower than the national rural average. Furthermore, the \$19 increases in net income per capita of rural households in Xinjiang between 1995 and 1997 was no greater than the rate of inflation. Thus, there has been virtually no increase in income for the people of this region over the past several years.

In rural areas of Xinjiang, each household has 4-6 persons. Thus, the net income for a family is between \$624 and \$936. If a family wants to purchase a PV system (a 22 Wp mono-silicon system, for example), their willingness to pay is typically about \$125. Households without electricity are able to pay for SHS/PV systems, and therefore, the PV market potential in Xinjiang is large. However, due to a lack of information about the availability of SHS/PV systems, most of the rural population does not know where to purchase such systems, or how to maintain them. Assistance from the central and local governments, as well as international agencies, is therefore required to realize the full market potential for PV systems in Xinjiang. With increasing income levels, many households in remote areas hope to obtain electricity services in the near future. However, as a result, there is growing interest in rural electrification strategies based on the development, promotion, and dissemination of renewable energy systems.

3. ECONOMICS OF STAND-ALONE RENEWABLE ENERGY SYSTEMS

To evaluate the energy and economic performance of PV, wind, and PV/wind hybrid systems for off-grid applications in rural settings, CEEP researchers developed the Rural Renewable Energy Analysis and Design Tool (RREAD)². Before discussing the details of RREAD, the stand-alone renewable energy systems, which RREAD evaluates, are described.

3.1 Stand-Alone Renewable Energy Systems

Typical stand-alone (i.e., not connected to an electric grid) renewable energy systems include single PV and wind systems. Less common, but of increasing interest, are small-scale PV/wind hybrid systems, which are equipped with both a PV panel and a wind turbine. A PV panel is a solar panel mounted with groups of photovoltaic cells that convert sunlight directly into electricity using semiconductors, in a manner similar to electronic transistors. A wind turbine is a wind-driven electrical generator, which converts the kinetic energy of wind into electricity through the rotation of the turbine's blades. In addition to electricity generation devices such as the PV panel and the wind turbine, stand-alone renewable energy systems are also equipped with — the so-called balance-of-system (BOS) components that include batteries, a charge controller and an inverter.

Since PV and wind energy technologies are both intermittent sources (i.e., they produce power only at certain times of the day) energy storage represents a critical need. In order to provide energy services to users whenever power is needed, some form of energy storage equipment must be installed. One possible form of storage is the battery. A PV panel and/or a wind turbine charge the battery bank during times of resource availability that then delivers the stored energy to the connected load on demand. To protect the battery bank from being over-charged by the PV panel and/or the wind turbine and to keep it from being over-discharged by electric appliances, a charge controller (also called a power regulator) is typically installed to switch off the current when the battery reaches its charging or discharging limits. Furthermore, to feed regular AC-powered

(alternating current) appliances, a DC/AC inverter is installed so that the batteries' DC power (direct current) can be converted to AC.³

A complete small-scale, stand-alone PV or wind system typically has an electricity generation device (a small PV panel or a wind turbine) equipped with a wiring setup and supporting structure as well as the necessary BOS components (i.e., the battery bank, the charge controller and the DC/AC inverter). A hybrid system has both a PV array and a wind turbine, as well as the other components just described. A typical stand-alone PV/wind hybrid system design is illustrated in Figure 3-1.

FIGURE 3-1: CONCEPTUAL DRAWING OF A STAND-ALONE HYBRID RENEWABLE ENERGY SYSTEM

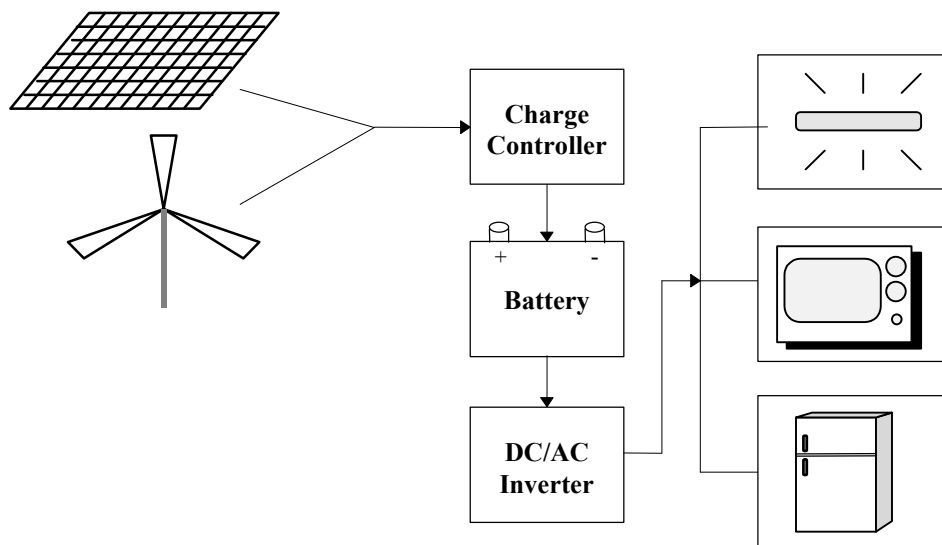

3.2 An Overview of RREAD

The spreadsheet model RREAD is a multidimensional simulation tool that helps evaluate decentralized energy options for rural development from a broad range of perspectives—technical, economic, social and environmental. RREAD consists of three modules: a data input module, a calculation engine and an output module (see Figure 3-2). It processes resource, economic and financial data in combination with information

² Dr. Bo Shen, who was a Policy Fellow with CEEP during 1998-99, is the principal architect of RREAD.

inputs on technology configurations and relevant social and environmental factors. RREAD assesses the energy availability, economic viability and the social and environmental value of a stand-alone PV, wind or PV/wind hybrid systems. It can also compare these renewable energy systems with competing stand-alone gasoline/diesel generators.

The input module consists of six sets of data: resource data, load data, system configuration, capital and operating costs, financial data and policy scenario information (e.g., the existence of tax credits, subsidies, and program initiatives to internalize social benefits/costs, etc.). The resource, load data and system configuration data are used to evaluate the system's overall energy performance, including energy output, resource-load matching capacity and service reliability. Cost, financial and policy data measure the economic, social and environmental values of using renewable energy systems. A detailed list of data required for running RREAD is provided in Appendix A.

Working through its calculation engine, RREAD reports the performance of both renewable energy systems and diesel generators. It estimates the energy output of an energy system, assesses the storage requirements of a battery bank, compares resource availability with load requirements, determines energy shortfalls, and calculates the system's economic costs. Figure 3-3 provides a logical flow chart to illustrate how RREAD works.

³Although it is not necessary to include an inverter, the prevalence of AC-powered appliances and lighting equipment makes this a practical necessity.

FIGURE 3-2: OVERALL STRUCTURE OF RREAD

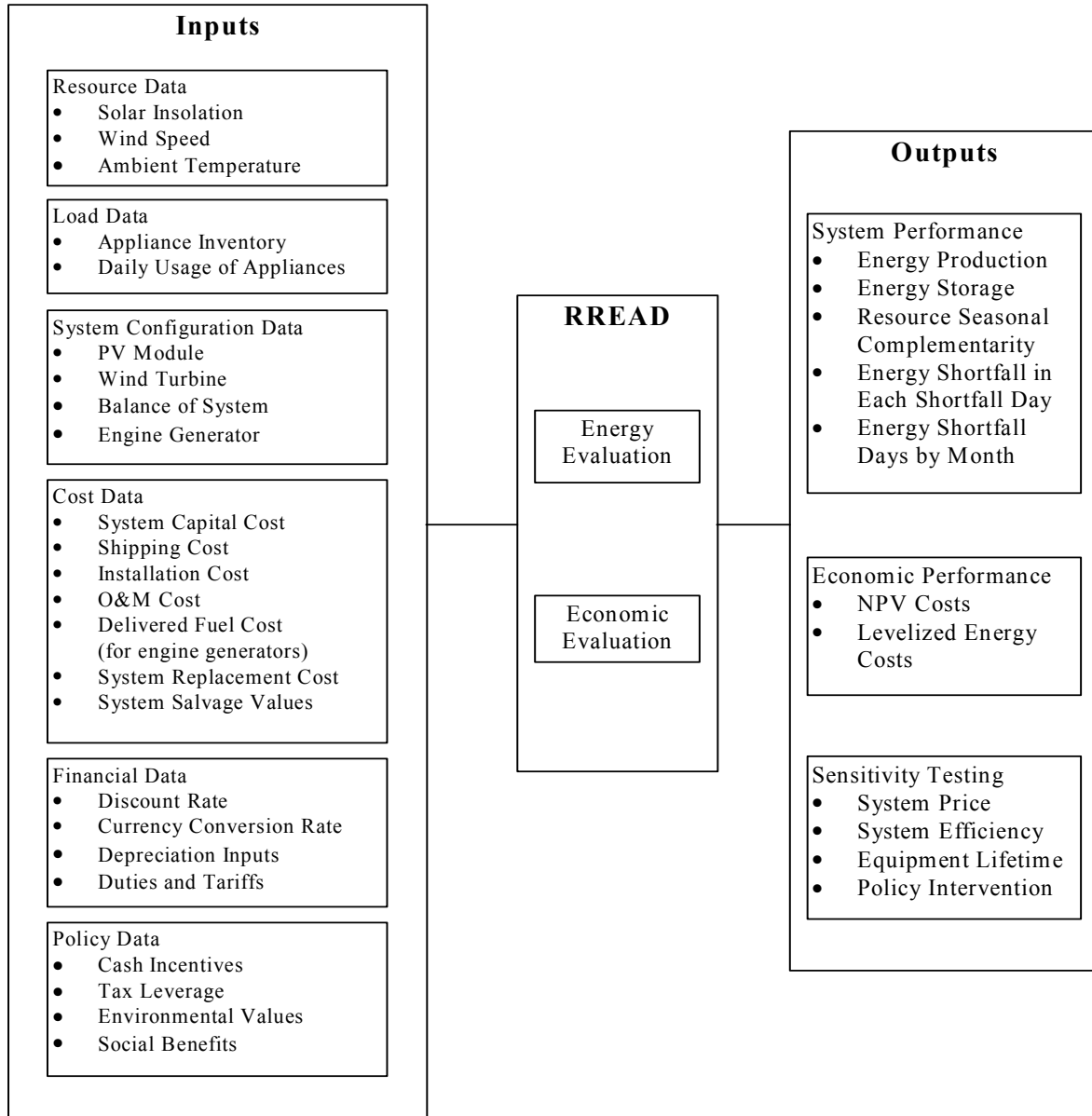
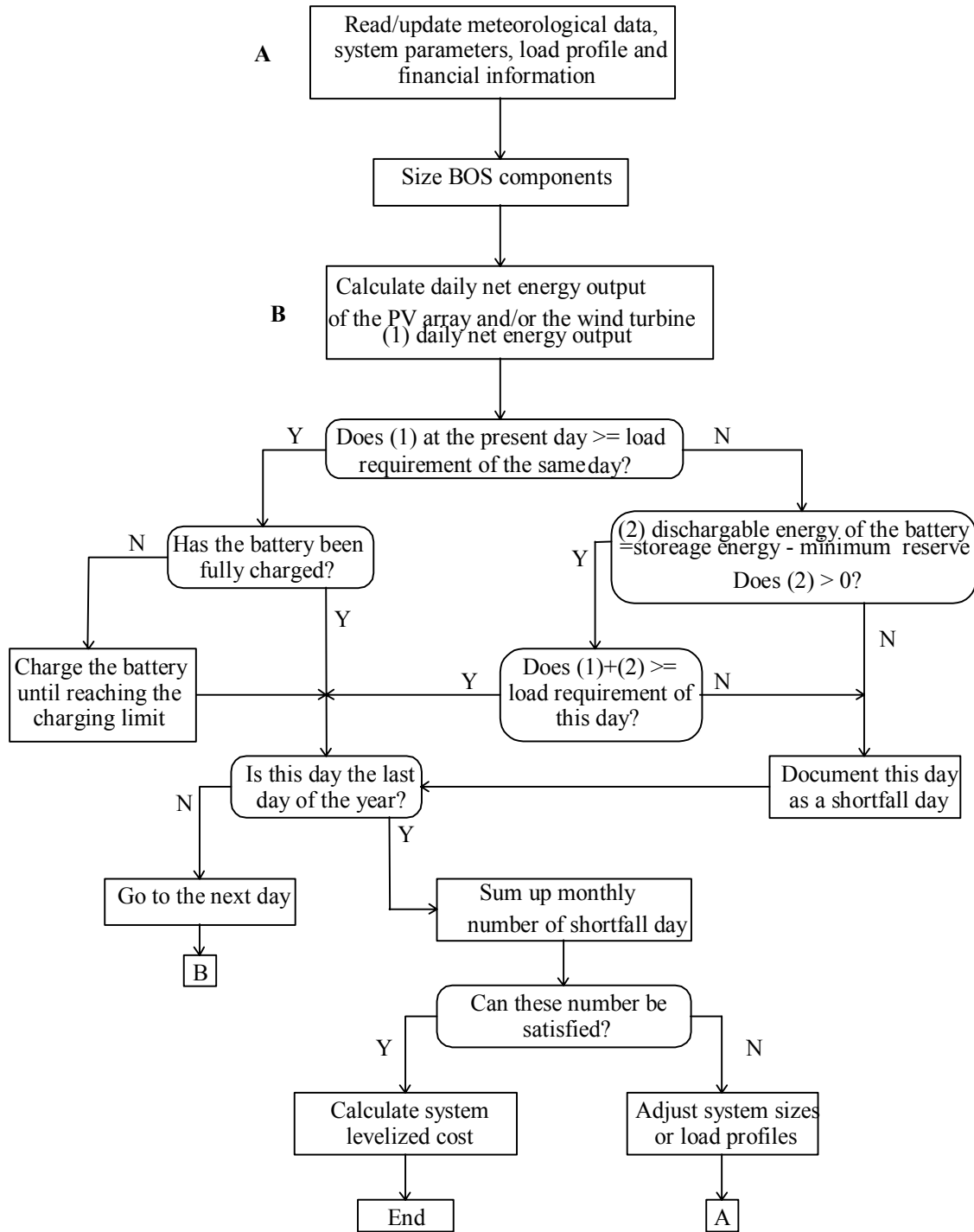

FIGURE 3-3: LOGICAL FLOW CHART OF RREAD



3.3 Energy Analysis

Technical issues including system design, supply capacity and energy reliability need to be addressed in the evaluation of different stand-alone renewable energy options. This chapter reviews these technical issues by describing how RREAD configures and sizes an energy system's components, estimates system generation capacity, and evaluates system reliability.

3.3.1 Sizing of Renewable Energy Systems

BOS components of a renewable energy system need to be properly sized. Use of incorrectly sized components could disrupt the effective operation of the system.

Unlike automotive batteries which are designed to produce an instantaneous high current to start an engine, batteries used in stand-alone renewable energy systems are specifically designed to operate regular household appliances that require a constant current over extended periods of use. The size of a battery bank used in stand-alone renewable energy systems is determined by several factors, including the battery's daily energy delivery value, its depth of discharge rate and its power reserve margin. From a supply perspective, battery size is to be set at a value equal to the energy sent to the battery bank each day from the generation device. From a customer perspective, however, battery size should equal a value commensurate with the amount of energy required by the customer's appliances each day. Since battery size is determined differently, depending on supply or consumption perspectives, RREAD calculates it in two ways. From a supply perspective, the battery's daily energy delivery value – expressed in ampere-hour (Ah) units – is derived by dividing the generation device's daily energy output (kWh) by the battery voltage (V).⁴ For example, the daily energy delivery value of a 12V battery bank would be 125Ah if it is equipped with a 100W wind turbine whose daily output is 1.5 kWh (i.e., $1,500\text{Wh} \div 12\text{V} = 125\text{Ah}$).

⁴Battery capacity is rated in Ampere-hours (Ah), which is derived from watt-hour (Wh) divided by voltage (V). A 100Ah, 6V battery can store up to 600Wh of electricity after being fully charged (i.e., $100\text{Ah} \times 6\text{V} = 600\text{Wh}$), and a 100Ah, 12V battery can hold 1.2 kWh electricity ($100\text{Ah} \times 12\text{V} = 1,200\text{Wh}$).

From a customer perspective, the battery's daily energy delivery value (Ah) can be determined by dividing the customer's daily energy requirements (kWh) by the battery voltage (V). It is important to note that the customer's daily energy requirements must include power losses from both the battery bank and the inverter (power losses occur when the battery is being discharged and when DC power is being converted to AC). Normally, there is a 10% to 30% round-trip loss for the battery bank (current entering the bank from the generation device and exiting the appliances, completes one round-trip) and a 5% to 10% loss during the energy conversion process. RREAD automatically estimates the power losses after component efficiencies are determined. Since energy losses may vary due to component quality and age, RREAD allows the user to specify BOS component efficiency values.

BOS component efficiencies are then divided by the total energy load to calculate the value of the battery's total daily energy delivery requirement — (the amount of energy that must be delivered by the battery bank to operate all appliances and cover for all power losses). For instance, if a household requires 1.5 kWh of electricity per day, the daily energy delivery value of the battery has to be at least 185Ah, assuming 75% efficiency for a 12V battery and 90% efficiency for the inverter (i.e., $1,500\text{Wh/day} \div 75\% \div 90\% \div 12\text{V} = 185\text{Ah/day}$).

A battery bank can be severely damaged by frequent over-discharges. To protect it from being overused, the battery bank needs to be sized large enough so that only a portion of its total stored energy will be used each time. This requirement is determined by the depth of discharge (DOD). For example, a 40% DOD is equivalent to a battery only being discharged at 40% of its total capacity each day. The DOD can be set from 30% to 80%, depending on the age and quality of the battery. New and high quality and specially designed 'solar' batteries tolerate deep discharges while old or low quality or car batteries, which are not designed for deep discharge can sustain only shallow discharges. RREAD allows the user to specify the DOD based on the battery's specific characteristics and age.

Since supply shortfalls in renewable energy system are more likely to occur when weather conditions interrupt renewable energy supply, a battery bank should have a reserve margin to ensure an uninterrupted flow of energy during unexpected weather conditions. Functioning like a reservoir, excess energy generated by the system from previous days is captured and stored by the battery bank and used on those days when the system cannot generate sufficient power. Normally, a battery's reserve margin is set at 2 to 3 days. This means that the battery bank should be capable of delivering at least 2-3 days of energy supply before being charged again.⁵ RREAD allows the user to specify the number of reserve days based on the local conditions and customer needs.

After the battery's daily energy delivery value is calculated and its depth of discharge and reserve margin are specified, RREAD calculates the required size of the battery bank by dividing the depth of discharge with the daily delivery value and then multiplying the quotient by the reserve margin. For example, a 12 V battery bank to be used in a household whose daily electricity consumption is 1.5 kWh, requires a total storage capacity of 926Ah (12V). The result is derived from the following three-step calculation:

Step 1: Estimating the daily delivery value requirement for the battery: $1,500\text{Wh/day (daily energy load)} \div 75\% \text{ (battery efficiency)} \div 90\% \text{ (inverter efficiency)} \div 12\text{V (battery voltage)} = 185\text{Ah/day}$.

Step 2: Estimating the battery's daily storage capacity requirement with a 40% DOD limit: $185\text{Ah/day} \div 40\% \text{ (DOD)} = 463\text{Ah/day}$.

Step 3: Estimating the battery's total capacity requirement with a 2-day reserve margin: $463\text{Ah/day} \times 2 \text{ days (reserve margin)} = 926\text{Ah}$.

The procedures for sizing the charge controller and the DC/AC inverter are comparatively simple. In RREAD, the charge controller is sized equal to the Watt power of the generation device. For example, if the rated power of a wind turbine is 200W, the

⁵Technically, because of the DOD that prevents the battery from being fully discharged each time, a battery bank has a larger storage capacity than the planned reserve margin. Taking the following case as an example, if 100Wh of electricity needs to be delivered each day, a fully-charged battery is capable of serving this need for $(100\text{Wh} \div 40\% \times 3 \text{ days}) \div 100\text{Wh} = 7.5$ days without being further charged (assuming a 40% DOD and 3 day reserve margin).

charge controller would be sized at 200W. For the inverter, RREAD sets the size equal to the rated Watt power of the generation device when using the supply perspective. When using the customer perspective, RREAD sets the inverter equal to the total load (in Watts) of all customer appliances that are likely to operate at the same time.⁶ If, for example, the total load of the customer's appliances is 500W, the customer needs a 500W DC/AC inverter.

3.3.2 Energy Output of Renewable Energy Systems

To determine how much electricity can be generated from a stand-alone PV, wind, or PV/wind hybrid system, the energy output from the PV panel⁷ and/or wind turbine must be calculated. To simulate output from a PV panel, resource information for a given site — including global horizontal irradiance (a measure of solar energy in units of watts per square meter) and ambient temperature — needs to be provided. This data can be found in a typical meteorological year (TMY) data file for the site under investigation.⁸ Global horizontal irradiance is then adjusted to the plane of array (POA) insolation values using site latitude and PV array angle. POA insolation values, PV module efficiency values, array size and ambient temperatures are then used in a RREAD algorithm to simulate hourly PV output.

For the calculation of wind turbine output, no other factor is as important as wind speed because wind power is a cubic function of wind speed. Hourly wind speeds,

⁶Theoretically, the inverter should be sized larger than the rated power of appliances so that it can handle both the surge requirements of the induction motors in refrigerators and water pumps and their continuous demand when operating for extended periods. In fact, today's inverters are designed with both surge and continuous capacity protection so that they are able to start high surge loads and provide continuous output as well. For example, a 500W inverter is often capable of running 500W continuous loads and 800W surge loads.

⁷The size of a PV panel is usually rated in peak Watts (W_p). The peak Watt output represents the maximum power produced under standard test conditions of 1,000 Watts per square meter (W/m^2) of solar insolation and 25°C ambient temperature. In practice, however, a PV panel's actual power output in Watts can exceed its peak watt output if sunlight intensity is superior to the above standard test condition.

⁸A typical meteorological year (TMY) data file is compiled to represent a "typical" year of weather for the site based on a multiple-year data record. Most TMY databases are constructed from 30-year weather records.

measured at the height of the anemometer, along with the turbine's power curve, are used to estimate hourly energy output values. A power curve correlates wind speed with the power output of a wind turbine. Since significant variations in hourly wind speeds could occur from one year to the next, RREAD requires multiple-year wind speed data to produce an 8,760-hour wind profile for a specific site. In cases where the site-specific hourly wind speed profile is not available, RREAD utilizes the site's monthly wind speed profile⁹ in conjunction with wind speed data from a comparable site to simulate a full 8,760-hour profile.

Once hourly energy output values of a stand-alone renewable energy system are estimated, RREAD aggregates the hourly values to compute daily, monthly, and annual values. Daily energy values are used to perform a resource-load matching analysis aimed at evaluating an energy system's ability to meet the end-user's daily energy needs on a reliable basis. The annual value is employed to calculate an energy system's levelized cost of energy production, while monthly values are used to evaluate the system's seasonal performance.

3.3.3 Reliability of Renewable Energy Systems

A reliability analysis of renewable energy systems is needed to determine the levels of energy service that systems can provide in meeting end-user needs. Reliability can be determined by comparing end-user requirements to system capacity. In RREAD, system reliability is measured by calculating the number of "shortfall days" and the magnitude of the energy shortfall on those shortfall days. The magnitude of an energy shortfall is the difference between energy demand and available supply. Shortfall days are those days when aggregate energy demand exceeds aggregate supply. RREAD estimates the magnitude of energy shortfalls on a daily basis and computes the number of "shortfall days" for each month. The number of shortfall days during each month reveals

⁹ A monthly wind speed profile is the site-specific description of the number of hours in each month that wind speeds from zero to, say, 30 meter per second (m/s) occur.

the seasonal energy shortage pattern, while the daily shortfall numbers indicate the severity of each energy shortage.

To perform the reliability analysis for a specific renewable energy system, the system user's peak energy demands must be known. A household appliance inventory and the daily operating schedules of these appliances can help estimate the household peak energy demands on a daily basis. For instance, a household which has a 60W TV that is watched 4 hours a day, two 25W lights each turned on for 4 hours each night, one 12W lamp used 5 hours daily and one 100W refrigerator whose compressor runs 10 hours per day, demands a maximum of 1.5 kWh electricity each day (i.e., $[60\text{W} \times 4 \text{ hours}] + [2 \times 25\text{W} \times 4 \text{ hours}] + [12\text{W} \times 5 \text{ hours}] + [100\text{W} \times 10 \text{ hours}] = 1.5 \text{ kWh}$).

It is important to note that there can be a variation in daily energy needs across seasons. For instance, lighting demands are likely to be less during summer months as a result of the extended daylight hours. To reflect the seasonal pattern of energy use, a household's annual 365-day load profile needs to be determined. This can be established by an energy audit and household survey.

After establishing a household's annual load profile, RREAD can be used to subtract the household's daily energy load from a system's daily net output, starting from the first day through the last day of the year. If the result is a positive number on a particular day, it indicates that a system's energy output is sufficient to meet that day's energy load. Excess output is then captured by the battery bank until the battery's maximum charging ceiling has been reached. If a negative number appears, an energy shortage has occurred. In this instance, stored energy from the battery can be used to make up for the shortage. If a negative number still appears after adding supplementary energy supply from the battery storage, a shortfall day occurs.

To reduce the potential energy shortfall days of a renewable energy system (i.e., to increase the system's service reliability), the system user can switch to larger generation equipment in order to receive more energy (a supply approach). One can also

achieve the goal of reducing potential energy shortfalls by controlling the household's peak loads, using a demand-side management (DSM) approach. For example, the household mentioned earlier had a daily peak demand in January of 1.5 kWh. Let's assume the available AC output from the renewable energy system, including the supplementary power supplied from the battery bank, was only 1.4 kWh in January. There would then be a 0.1 kWh energy shortfall on some January days. The household could manage to offset this energy insufficiency by either using its 60W TV and its two 25W lamps for only three hours instead of four, or by turning on only one of the two 25W lamps so that the household's energy consumption on that day could be kept at or below 1.4 kWh. A household could also reduce its energy shortfall by adjusting the routine of its appliance usage. For example, if energy shortfalls are more likely to happen in cold winters in a specific area, a household located in this area could avoid energy shortfalls by turning off its refrigerator during the winter. By examining approaches of managing daily loads or adjusting appliance usage routines, RREAD provides opportunities for demand management to be a meaningful option in rural energy service.

3.3.4 Evaluation of Competing Engine Generator Systems

In remote areas where grid-connected energy services are not available, stand-alone engine generator systems powered by fossil fuels such as gasoline or diesel are normally operated as a competing option to provide electricity to remote rural households. Unlike a renewable energy system that uses intermittent energy resources and generates DC power, an engine generator can be operated continuously to produce AC power directly, provided fuel supply is available. Although engine generators are capable of serving continuous duty cycle equipment such as refrigerators and electric pumps on a 24-hour-a-day basis, fuel supply constraints and intensive maintenance requirements make the option of running these generators for long hours almost impossible in remote areas. It is, therefore, more economical and efficient to configure an engine generator with necessary BOS components (i.e., a charge controller, a battery

bank and an inverter¹⁰) so that the power needed for running continuous duty cycle equipment could be delivered by the battery. Of course, other appliances such as TVs, cassette players and lamps, which are used only for a short period of time in each day could still be plugged directly into the engine generator to avoid using larger BOS components.

For an engine generator system, the procedures for sizing its BOS components are the same as those applied to a renewable energy system. Daily load requirements of the continuous duty cycle equipment along with several other factors concerning BOS components such as potential power losses from energy storage and conversion, the battery's daily DOD and the battery's reserve margin (in case of insufficient fuel supply) are used to obtain the size of the battery bank. The size of the charge controller is equal to the rated power of the engine generator. For the inverter, it is set equal to the total rated power of all continuous duty cycle appliances because only these appliances are hooked up to the battery. To give an example, a 100W inverter, a 500W charge controller and a battery bank with a storage capacity of 310Ah (or 3.7 kWh) needs to be installed if a 100W refrigerator whose compressor runs 10 hours a day along with other non-continuous duty cycle appliances are powered by a 500W engine generator (assuming a 40% DOD as well as 75% and 90% power efficiency ratings for the battery and the inverter, respectively). The following calculations are performed to obtain the size of the battery bank:

- (1) Refrigerator's daily consumed energy: $100\text{W} \times 10 \text{ hours/day} = 1 \text{ kWh/day}$;
- (2) Actual energy requirement after considering power losses: $1\text{kWh/day} \div 75\% \div 90\% = 1.48 \text{ kWh/day}$;
- (3) Required battery storage capacity with 40% of DOD: $1.48 \text{ kWh/day} \div 40\% = 3.7 \text{ kWh}$.

¹⁰In this configuration, since AC power generated from the engine generator is rectified to become DC power when the battery is charged, a DC/AC inverter is needed to change the DC into AC in order to feed the AC-powered appliances.

By calculating the energy output values of an engine generator, RREAD can simulate the generator's energy performance. The calculation of output is quite simple for a system without BOS equipment (i.e., no continuous duty cycle appliances being served). For example, if a 500W engine unit is operated for 4 hours per day, it can generate 2 kWh of electricity daily, or 730 kWh annually. However, if BOS components need to be integrated with the engine generator because continuous duty cycle appliances must be served, output calculations must also include potential power losses from energy storage and conversion. As a result, the engine's output is reduced. For instance, a 500W engine unit which runs 4 hours a day can only generate 1.52 kWh of electricity daily and 554 kWh annually, assuming battery and inverter efficiency ratings of 75% and 90% respectively, (i.e., $2 \text{ kWh/day} - [(1 \text{ kWh/day} \div 75\% \div 90\%) - 1 \text{ kWh/day}] = 1.52 \text{ kWh/day}$, $1.52 \text{ kWh/day} \times 365 \text{ days/year} = 554 \text{ kWh/year}$), here suppose a refrigerator in the household need 1 kWh to keep continuous running.

3.3.5 Social and Environmental Factors Beyond the Energy Analysis

Renewable energy systems need to be evaluated based on their performance and reliability. However, energy performance should be evaluated not only in technical terms, but also in a broader perspective that takes into account social and environmental factors. In the context of sustainable development, the purely technical issues of reliability and bulk energy production should not be the primary concerns. Rather, the ability of energy production to meet the basic needs of rural people, while minimizing deleterious environmental impacts is the most important evaluative criteria of rural energy systems.

For energy resources to be evaluated in terms of their contribution to sustainable rural development, the energy performance has to be evaluated in such a way that the electricity generated would replace the conventional wood and fossil fuels that have adverse environmental effects and technologies failed to secure aims of social equity. If renewable energy options can meet basic energy needs of the poor and promote rural economic and social development without threatening human health or environmental

sustainability, they would be evaluated positively in comparison to conventional energy options. Overall, while the technical factors of an energy system need to be evaluated, the social and environmental dimensions of energy use cannot be ignored.

3.4 Economic Analysis

The evaluation of the energy performance of a decentralized energy system is a very important task because it will help us compare the technical capability of different energy options to meet rural energy needs. Equally important, an economic analysis of decentralized energy systems can help us evaluate the cost-effectiveness of multiple energy options. RREAD is suitable for this purpose because it can be used to calculate levelized energy costs of stand-alone PV, wind, PV/wind hybrid and fossil fuel generator systems. In order to calculate the levelized costs, however, RREAD first needs to determine the cost stream of each stand-alone energy system and then calculate the net present value (NPV) of those costs.

3.4.1 Preparation of the Cost Stream and Estimation of NPV

When using a stand-alone energy system, a stream of costs occurs over the span of its useful lifetime. In order to determine this cost stream (the so-called cash flow), RREAD estimates the year-by-year capital and operating expenditures incurred during the evaluation period. These expenditures include generation equipment costs, BOS component costs, and annual operating and maintenance (O&M) costs. Generation equipment costs include hardware, transportation and set-up for generation devices such as PV panels, wind turbines or fossil-fuel generators. The BOS component costs represent the expense of purchasing, delivering and installing the battery bank, charge controller and inverter. Both generation equipment and BOS component cost streams include initial and replacement costs. O&M expenses cover regular service, maintenance and repair costs (e.g., lubrication and bushing repairs for fossil fuel generators, and array surface washing and electrical connection inspection for PV systems). For generators, the O&M costs also include the delivered fuel cost. This is an aggregate cost determined by fuel prices in the local market and the average cost of delivering the fuel to site.

Since some hardware may still have usable value beyond the evaluation period, RREAD employs a straight-line depreciation method to credit the system with the residual values of the equipment. Straight-line depreciation is one of two principal types of depreciation methods: it allocates the cost of the equipment in equal amounts for each accounting period (a year in RREAD) so that the value of the equipment is reduced evenly over the course of its lifetime.¹¹ Hardware “scrap” values are also counted as credits in RREAD’s treatment of system costs.

After system expenditures and credits are estimated over the evaluation period, the cost streams are discounted in order to calculate the net present values. RREAD utilizes the following formula to discount all future costs and credits to their present values in the time horizon of the evaluation period:

$$(\text{NPV})_n = C_n / (1+d)^{n-1}$$

where,

$(\text{NPV})_n$ = net present value in the year n,

C_n = net cost value (after subtracting credits from costs) in the year n, and

d = discount rate.

RREAD sums up all discounted future values to arrive at a total NPV. The total NPV is then used, along with the annual energy value of a stand-alone energy system, to obtain the system’s levelized energy cost.

3.4.2 Calculation of Levelized Energy Costs

The total NPV cost of an energy system can be standardized over the evaluation period by obtaining a *levelized* annual NPV using the annuity concept in financial analysis. The annuity represents a series of constant cash payments made over a

¹¹Another method, called accelerated depreciation, allocates a large proportion of the system costs to earlier accounting periods and a smaller proportion to later periods.

continuous period. The following equation is applied in RREAD to compute the levelized NPV cost:

$$L = NPV(1+d)^n / (1+dt)[1 - (1+d)^{-n}] / d$$

$$(L = NPV/n, \text{ when } d = 0),$$

Where,

L = levelized NPV,

NPV = total NPV over the evaluation period,

d = discount rate,

n = number of years in the span of the evaluation period, and

t = an indicator determining when payments are due (t equals 0 if payments are due at the end of the year and equals 1 if payments are due at the beginning of the year).

After the levelized annual NPV (\$/year) is calculated, RREAD divides it by an annual energy value (kWh/year) to obtain the levelized energy cost (\$/kWh). RREAD determines the annual energy value from both a supply and a demand perspective. Using a supply perspective, the model sets the annual energy value equal to an energy system's net production. Using a demand perspective, the model sets the annual energy value equal to the system user's annual energy consumption. However, since resource availability establishes a cap on consumption level, the supply perspective would be used when annual consumption value exceeds the system's generation capacity.

3.4.3 Social and Environmental Factors Beyond Conventional Economic Analysis

An economic analysis of decentralized energy technologies is important because it helps determine the economic viability of various energy options in rural development. In the context of sustainable development, however, an conventional economic analysis is insufficient because it relies solely on financial performance of an energy option. Social and environmental implications of energy options must also be considered if an objective evaluation on sustainability ground is to be achieved.

Analysis needs to go beyond the cost of equipment and the potential for financial return. Social and environmental advantages of renewable energy, where possible, need to be quantitatively expressed as well. These advantages include less local air and water pollution and decreases in local land degradation through a reduction in the consumption of wood and fossil fuels. There is also the potential improvement in social equity as renewable energy systems tend to be more widely suited to rural low-income users. When social and environmental advantages cannot be quantified, it is essential that these contributions be qualitatively expressed.

3.5 Sensitivity Analysis

In order for an analytical model to be dynamic, a sensitivity study is required, that takes into account changing economic, technical, market and policy conditions. By testing a number of variables, RREAD performs a series of sensitivity analyses aimed at examining the impact of adjustments in technologies, markets, and government policies on the use of off-grid, stand-alone energy systems.

3.5.1 Impacts of Technological Improvements and Market Development on Renewable Energy Use

Advances in renewable energy technologies and the development of renewable energy markets can have significant impacts on the use of stand-alone renewable energy systems. For example, more efficient PV modules and wind turbines can considerably improve the energy performance of PV and wind systems. Reduced prices of PV modules and wind turbines, due to manufacturing improvements and the development of larger markets, will reduce the costs of using these systems. Prolonged equipment lifetimes, due to the use of innovative materials, can also increase the cost-effectiveness of renewable energy systems.

RREAD evaluates the potential impacts of technological improvements and market development on PV, wind and PV/wind hybrid systems. It tests the sensitivity of

each system's energy and economic performance with respect to a number of variables, such as the efficiency of PV modules and wind turbines, renewable energy equipment prices and the service lifetime of system components.

3.5.2 Impacts of Policy Interventions

Altering existing government policies (tax, financial, energy, environmental and other relevant policies) or implementing new policies can have a great impact on the use of renewable energy technologies in rural electrification. Stricter environmental standards, for example, can cause the additional costs of environmental destructive technologies to be considered in energy markets. Favorable tax policies can provide renewable energy technologies with benefits equal to their non-market advantages and thereby improve their competitiveness relative to fossil fuel-based technologies. By conducting a series of policy scenario analyses, RREAD can examine the potential impacts of important policy changes on the economics of stand-alone renewable energy systems. For example, the model can evaluate the sensitivity of renewable energy systems to government subsidies, customer rebates and import duties. The model can also compare the cost-effectiveness of different energy technologies in the wake of rising gasoline or diesel fuel prices due to changes in environmental policy.

3.6 Summary

A comprehensive, yet easy-to-understand, computerized analytical tool, RREAD has been discussed in detail in this chapter. RREAD is designed to evaluate decentralized renewable energy technologies including PV, wind, and PV/wind hybrid systems, in the context of sustainable rural energy development. This chapter has documented the energy, economic and policy analyses performed by RREAD. This information can assist analysts in designing system configurations, evaluating energy capacities, determining system reliability, assessing system economics and comparing renewable energy systems with competing options.

This chapter has also described the sensitivity analyses performed by RREAD. These analyses are designed to examine the potential impacts of technological improvements, market developments and policy interventions on the use of renewable energy technologies in rural electrification.

4. ECONOMICS OF STAND-ALONE RENEWABLE ENERGY SYSTEMS IN WESTERN CHINA

4.1 Resource Evaluation for IMAR, Qinghai, and Xinjiang

Western China's wind and solar resources are significant. The region has important experience in the exploitation of these resources. The IMAR is a world leader in the development of small wind turbines for use in rural settings (see, e.g., Byrne et al, 1998). Both Qinghai and Xinjiang have made important studies in the development of solar home systems for rural users. But each province's resource opportunities differ and need to be developed differently.

IMAR is rich in both wind and solar resources. Studies find that wind and solar resources are complementary: during winter months in IMAR when solar energy is low, wind energy is high, while in summer months when wind energy is low, solar energy is high (Byrne et al, 1998) . This suggests that wind-PV hybrid systems have the ability to provide stable electricity supplies for rural users.

In Qinghai, only a few counties, such as Menyuan County, have rich wind potential. For most counties in Qinghai, the wind resource is modest. However, the solar resource is exceptional. The Chinese Academy of Meteorological Science (CAMS) rates Qinghai's radiation as among the best in the country. Qinghai's solar radiation is better than IMAR (yearly sunshine hours are 20% longer than in IMAR).

The wind resource in Xinjiang is less substantial than in Qinghai or IMAR. However, this Autonomous Region's solar resource is abundant. In fact, Xinjiang has more sunshine hours than Qinghai on average. Table 4-1 provides a comparison of wind and solar resources in the regions covered in this study.

TABLE 4-1: WIND AND SOLAR ENERGY RESOURCES IN WESTERN CHINA

	Wind energy density (W/m ²)	Hours of wind speeds above 3 m/s per year	Hours of wind speeds above 6 m/s per year	Total solar insolation per year (kWh/m ²)	Hours of sunshine per year
Resource rich region as defined by CAMS	>150	>4,000	>1,500	>1,500	>2,800
Inner Mongolia	100-300	4,000-7,000	1,000-4,000	1,400-1,740	2,800-3,400
Si Zi Wang	150-200	5,000-7,000	2,000-3,000	1,610-1,700	3,100-3,300
Su Ni Te You	200-250	6,000-7,000	3,000-3,500	1,585-1,670	3,100-3,200
A Ba Ga	150	4,000-5,000	1,500-2,000	1,530-1,610	3,000-3,200
Dong Wu Zhu Mu Qin	100-150	4,000-5,000	1,500-1,700	1,420-1,560	2,800-3,000
Qinghai	-	1,168-5,912	184-1,304	1,829-2,014	4,386-4,476
Mengyuan	-	5,912	1,304	1,853	4,447
Dulan	-	3,976	360	2,014	4,443
Maqin	-	3,304	888	1,871	4,386
Nangqian	-	1,168	184	1,829	4,476
Xinjiang	-	906-2,700	18-876	1,708-2,006	4,406-4,704
Qinghe	-	1,890	288	1,811	4,505
Gongliu	-	1,562	96	1,708	4,704
Tuokx	-	2,700	876	1,865	4,473
Qiemo	-	2,298	324	2,001	4,476
Pishan	-	906	18	2,006	4,406

Source: Ministry of Agriculture of China, 1999.

4.2 Levelized Cost Analysis

Levelized cost analyses were performed for existing household-scale renewable energy systems in the three provinces. There were 21 configurations of PV, wind and hybrid systems under evaluation.

PV systems: 22Wp, 35Wp, 60Wp, 75Wp, 100Wp, and 120Wp ;

Wind systems: 100W, 200W, and 300W;

Hybrid systems: 35Wp - 300W Wind, 60Wp- 300W Wind, 100Wp- 300W Wind, 120Wp- 300W Wind, 35Wp- 200W Wind, 60Wp- 200W Wind, 100Wp- 200W Wind, 120Wp- 200W Wind, 35Wp- 100W Wind, 60Wp - 100W Wind, 100Wp - 100W Wind, 120Wp - 100W Wind.

All systems utilize Chinese-made PV arrays, except for the 120Wp system which is US technology. The wind generator systems in the case study are all made by local

Chinese manufacturers and deployed in three sizes: 100W, 200W and 300W wind turbines. Wind turbines are complemented with 35Wp-60Wp PV for small hybrids and 100Wp-120Wp PV devices for large hybrids. All systems are evaluated for AC loads and incorporate specially-designed, locally-made lead acid batteries (40% of DOD), charge controllers and DC/AC inverters.

The PV systems have an expected lifetime of 15 years while the wind turbines normally last 10 years. Battery lifetime, as claimed by manufacturers, is 3 years for a wind-only or a small PV/wind hybrid system, 4 years for a PV-only system and 5 years for a large PV/wind hybrid system. Field experience, however, suggests that these specially-designed batteries normally last only one year for wind and small hybrid systems and two years for PV and large hybrids. The charge controllers and the DC/AC inverters typically have a lifetime of 10 years.

Levelized cost comparisons for household-scale PV, wind, PV/wind hybrid systems were prepared for eleven counties (two in IMAR, five in Xinjiang and four in Qinghai). Assumptions and parameters used for the levelized cost analysis of household-scale systems are described in Table 4-2. Each system was evaluated at its maximum energy (kWh) generation capacity. In order to compare the economics of different technologies, we based our analysis on installed costs of all systems.

The PV systems under evaluation can serve only small household loads, from 120 kWh to 240 kWh per year (depending on county). Wind turbines can serve modestly larger loads, ranging from 200 kWh to 640 kWh per year.

Household surveys conducted in IMAR, Xinjiang and Qinghai revealed that most families consume 300Wh-600 Wh per day, mainly for lighting and to power radios or small black & white TVs. When a refrigerator is introduced, daily consumption rises to 1.2 kWh-1.6 kWh. The comparatively larger consumption levels can only be served by the higher rated wind turbines and hybrids. Our analysis indicates that the least-cost

configuration for household-scale, stand-alone generation differs among the counties and provinces. (see Tables 4-3, 4-4, 4-5).

TABLE 4-2: ASSUMPTIONS AND PARAMETERS USED IN THE ANALYSIS OF HOUSEHOLD SYSTEMS

Parameters	Wind	PV	PV/wind hybrid
System types	100 W-300 W	22Wp-120Wp	35Wp-120Wp, PV with 100-300 W wind turbine
System total capital cost (\$W ⁻¹)	\$1.70-\$2.78	\$7.39-\$7.55	\$2.28-\$3.54
Wind turbine or PV array as % of total cost	43%-61%	83%-85%	60%-77%
system lifetime	10 yrs	15 yrs	10 yrs
Discount rate	12%	12%	12%
NPV evaluation period (yrs)	10	10	10
Battery cost (\$kWh ⁻¹)	\$36	\$36	\$36
Battery lifetime (yrs)	3	4	5
Battery depth of discharge (%)	40%	40%	40%
Inverter cost (\$kWh ⁻¹)	\$140-\$320	\$140-\$320	\$140-\$320
Inverter lifetime (yrs)	10	10	10
Controller cost (\$kW ⁻¹)	\$82-\$116	\$82-\$116	\$82-\$116
Controller lifetime (yrs)	10	10	10
Energy losses from BOS (%)	32.5%	32.5%	32.5%
Annual O&M cost (\$ yr ⁻¹)	\$2.50	\$2.50	\$5.00

TABLE 4-3: LEVELIZED COSTS FOR PV, WIND AND HYBRID SYSTEMS IN IMAR

System	County	Output range (kWh yr ⁻¹)	Levelized cost (\$ kWh ⁻¹)
Wind-only	Su-Ni-Te-You	330~640	0.25~0.26
	Dong Wu Zhu Mu Qin	196~330	0.31~0.37
PV-only	Su-Ni-Te-You	40~225	0.70~0.88
	Dong Wu Zhu Mu Qin	37~205	0.76~0.94
PV/wind Hybrids	Su-Ni-Te-You	400~860	0.30~0.39
	Dong Wu Zhu Mu Qin	256~535	0.39~0.50

TABLE 4-4: LEVELIZED COSTS FOR PV, WIND AND HYBRID SYSTEMS IN XINJIANG

System	County	Output range (kWh yr ⁻¹)	Levelized cost (\$ kWh ⁻¹)
Wind-only	Qinghe	48~88	0.83~1.00
	Gongliu	21~50	1.32~1.72
	Tuokxun	100~212	0.46~0.49
	Qiemo	56~102	0.73~0.85
	Pishan	8~23	2.90~4.11
PV-only	Qinghe	73~400	0.45~0.54
	Gongliu	63~344	0.51~0.62
	Tuokxun	60~325	0.52~0.64
	Qiemo	58~318	0.54~0.66
	Pishan	55~300	0.56~0.68
PV/wind Hybrids	Qinghe	200~488	0.46~0.70
	Gongliu	121~394	0.54~0.88
	Tuokxun	261~538	0.46~0.52
	Qiemo	149~420	0.53~0.72
	Pishan	95~324	0.62~1.16

TABLE 4-5: LEVELIZED COSTS FOR PV, WIND AND HYBRID SYSTEMS IN QINGHAI

System	County	Output range (kWh yr ⁻¹)	Levelized cost (\$ kWh ⁻¹)
Wind-only	Dulan	75~153	0.50~0.62
	Mengyuan	188~342	0.31~0.36
	Nangqian	27~52	1.21~1.51
	Maqin	120~230	0.40~0.46
PV-only	Dulan	60~328	0.52~0.64
	Mengyuan	58~320	0.53~0.65
	Nangqian	47~257	0.63~0.78
	Maqin	55~304	0.55~0.67
PV/wind Hybrids	Dulan	170~481	0.47~0.60
	Mengyuan	282~663	0.36~0.44
	Nangqian	102~310	0.66~1.02
	Maqin	208~533	0.44~0.52

The quality of renewable energy resource influences the generating capacity of the PV and wind components by county or by province, but it does not affect the overall ranking of the most to least costly means of providing energy service. Nor does it significantly affect the magnitude of the cost differences among the technologies. Figure

4-1 depicts the results of our system analysis for the counties of Su Ni Te You and Dong Wu Zhu Mu Qin. From this figure, nearly identical cost patterns can be seen, even though Su Ni Te You has far better wind and solar resources. Note, here the wind power cost increases as the load increases due to the different power output curves for 100W, 200W and 300W wind turbine systems.

FIGURE 4-1: LEVELIZED COSTS FOR PV, WIND, GASOLINE GEN-SET AND HYBRID SYSTEMS IN SELECTED COUNTIES IN IMAR, CHINA

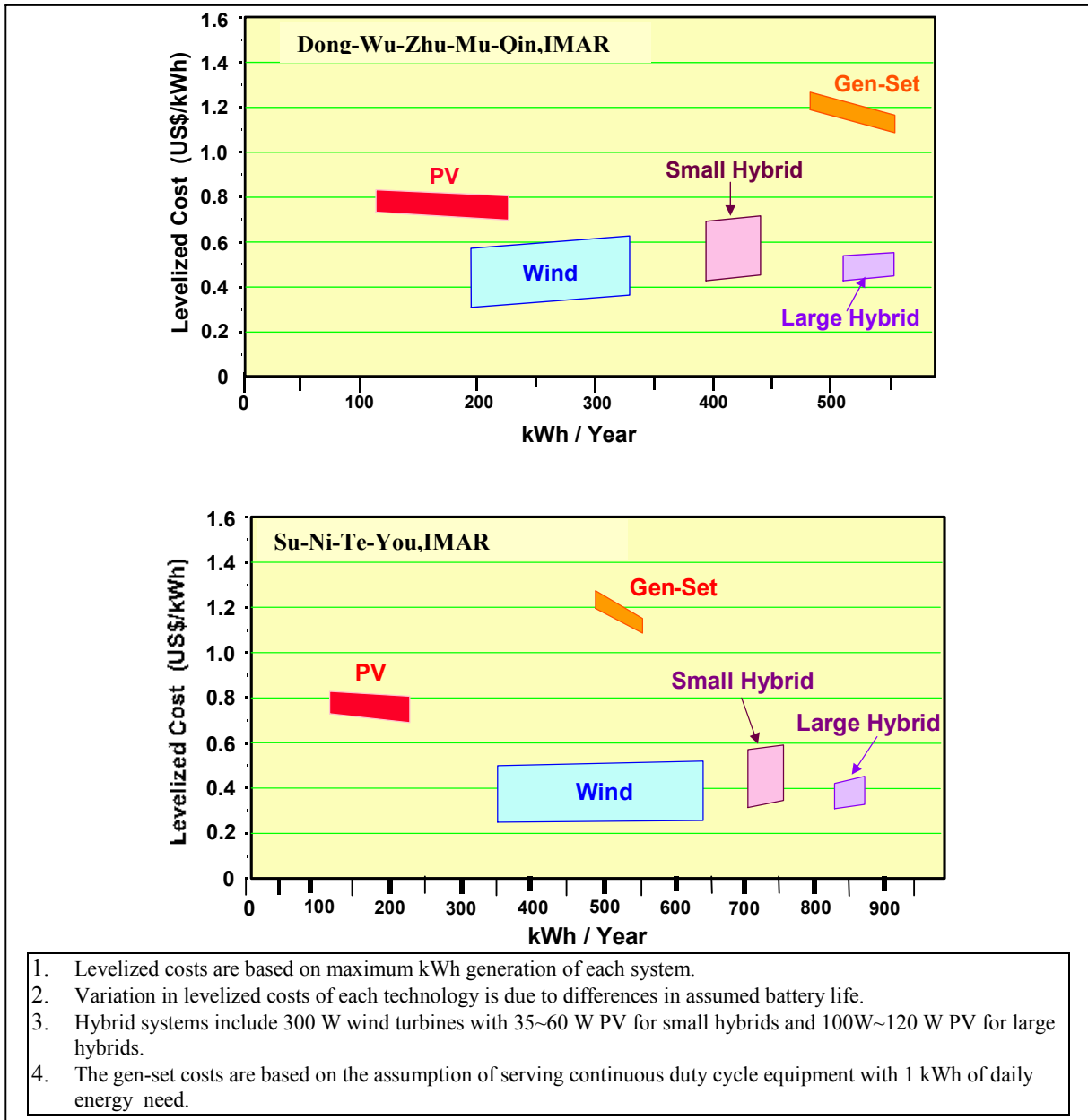

Levelized cost analyses conducted by CEEP suggest that wind-PV hybrid systems can meet increased energy demand at relatively stable costs for users in IMAR. In fact, such hybrids are less expensive than gen-sets, which can suffer long down-times as maintenance needs, parts failures and fuel shortfalls cause interruption of service.

Our levelized cost analyses for the selected counties in IMAR indicates that, Su Ni Te You County has the lowest cost renewable energy options in the region (Figure 4-1). CEEP's levelized cost analyses for the selected counties in Xinjiang show that Tuokxun County offers the most affordable renewable energy alternatives (Figure 4-2). Enlarging the same methodology in Qinghai, Mengyuan County is found to have most economical renewable energy options (Figure 4-3).

FIGURE 4-2: LEVELIZED COST ANALYSIS FOR PV, WIND AND HYBRIDS IN TUOKXUN, XINJIANG, CHINA

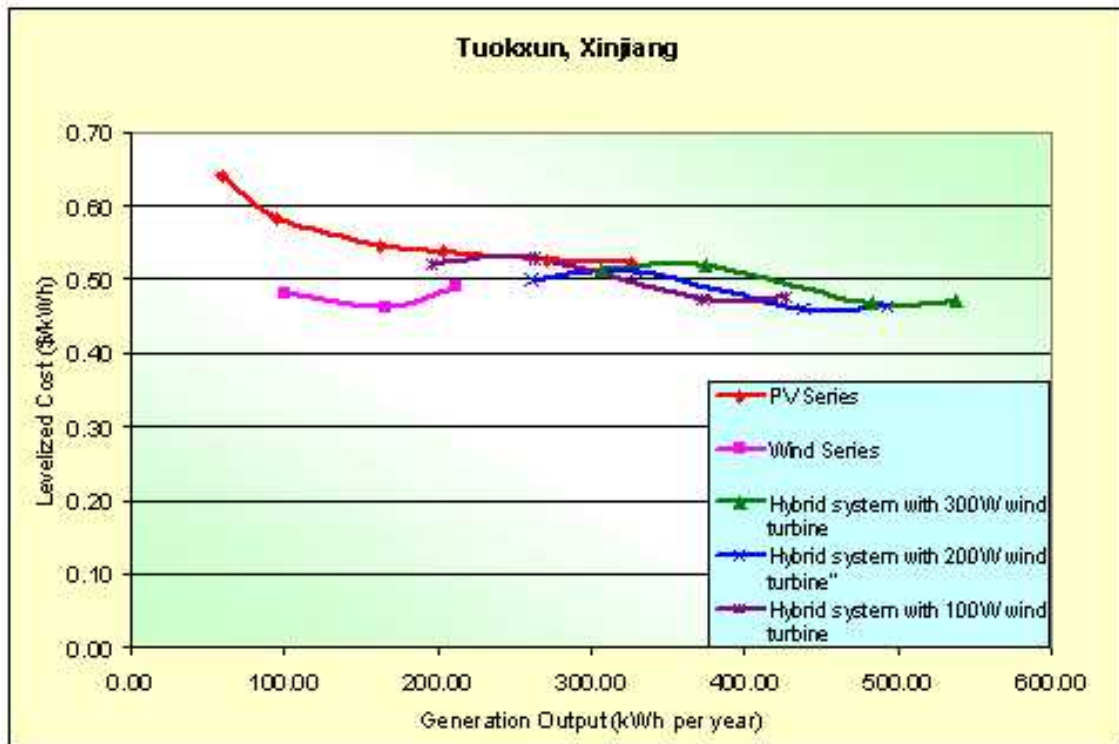
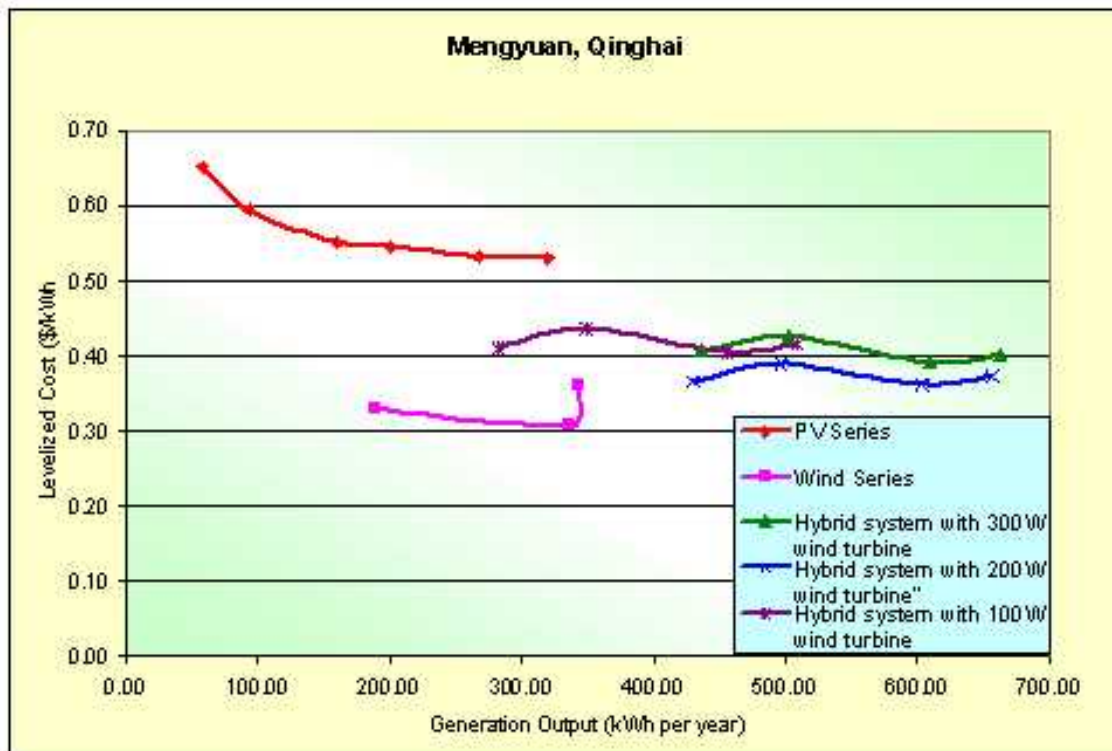

FIGURE 4-3: LEVELIZED COST ANALYSIS FOR PV, WIND AND HYBRIDS IN MENGZYUAN, QINGHAI, CHINA



The lowest levelized cost for each county that could be provided by the 21 renewable system was obtained. In order to correlate the spatial wind and solar resource distribution with levelized costs, ARCVIEW, a geographic information software was employed. Using ARCVIEW, researchers at CEEP created maps displaying wind resource distribution (4m/s and above, 6m/s and above, solar resource distribution, levelized cost and system selection for the eleven counties in the provinces of Qinghai, Xinjiang and IMAR (see Figures 4-4, 4-5, 4-6, 4-7).

These four maps provide important result for this report. Through them, it is possible to identify the type(s) of renewable energy system that are best suited in terms of resource availability and economic value for rural households living in specific counties. These maps can also assist public policy, and business decision making (including decision about investment and market opportunities). Thus, provincial government

planners and policy makers can set technology and market development priorities, with the aid of these maps; international organizations can learn what are the technology transfer, joint venture, capacity-building and financing opportunities and needs of the region; and business strategy for marketing renewable energy technology and investing in market infrastructure can be targeted to best serve rural community energy demand.

As Figure 4-4 and 4-5 indicate, the wind resource in IMAR is substantial in nearly all counties. Wind speeds in excess of 6m/s for more than 3,000 hours per year can support community-based and larger scale wind projects. There are many counties in the IMAR that meet this criterion. When 4m/s wind speeds can be affected for more than 3,000 hours per year, small-scale wind systems can profitably compete with conventional gen-set to meet the needs of off-grid rural users. Here again, most counties in the IMAR would qualify.

By contrast, only a smaller number of counties in Xinjiang and Qinghai offer promising resource conditions for wind market development. A few counties in the northern reaches of Xinjiang and even fewer counties in north and central Qinghai can support small-scale wind development.

The distribution of the solar resource is nearly the reverse spatially (see Figure 4-6). Most counties in Inner Mongolia have reasonably good solar radiation and could suggest at least small-scale, complementary solar development in conjunction with wind. However, nearly all counties in Qinghai receive significant solar radiation (>1,800 kWh per m²). Solar PV home systems and community-scale PV generation would appear to be technically feasible in many parts of Qinghai. The case of Xinjiang is really as encouraging. The southern and western counties of this autonomous region have good to excellent solar radiation and offer real opportunities for development of solar PV home systems and community PV generation.

If the resource conditions are compared with levelized cost (Figure 4-7), it is possible to identify specific market opportunities for small-scale, stand-alone wind, PV,

and wind-PV hybrid systems. For the IMAR, stand-alone wind offers the lowest cost for rural off-grid users in most counties, but there are several counties where hybrid systems are the least-cost option. In Xinjiang and Qinghai, small-scale, stand-alone PV systems are the most economical choice for the bulk of the region. The hybrid market is modest in scale for these provinces, but can be increasingly important as household demand for electricity grows.

Together, Figures 4-4 to 4-7 suggest a clear renewable energy development agenda for Western China. Wind and wind-PV hybrid systems have significant potential in the IMAR. Because these systems offer the least cost means of electricity supply to off-grid rural users, they should have policy and business priority and should receive the highest attention of international organizations seeking to support the IMAR's development aspirations. For Xinjiang and Qinghai, stand-alone PV systems should receive highest priority from policy makers, the business community and international organizations. A targeted effort to develop wind-PV hybrids is desirable for some counties in these two provinces.

With the encouraging results captured in Figures 4-4 to 4-7, the analysis now turns to questions of market assessment – what are the characteristics of rural users interested in purchasing electricity generation and what might be the size of the market for small scale, stand-alone wind, PV and wind-PV hybrid systems. These questions are addressed in Chapters 5 and 6.

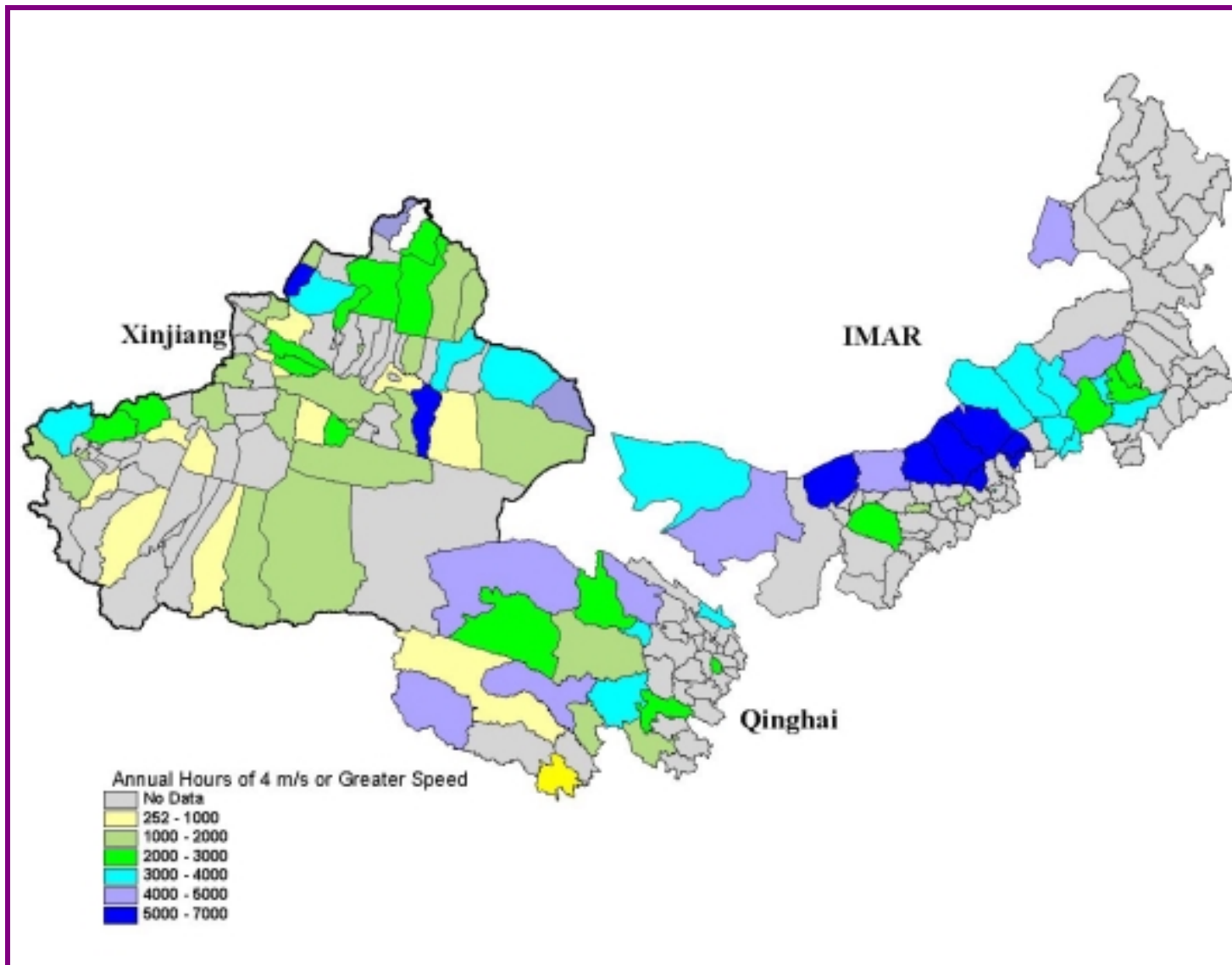

FIGURE 4-4: WIND RESOURCE DISTRIBUTION (WIND SPEED \geq 4 M/S) IN QINGHAI, XINJIANG AND IMAR, CHINA

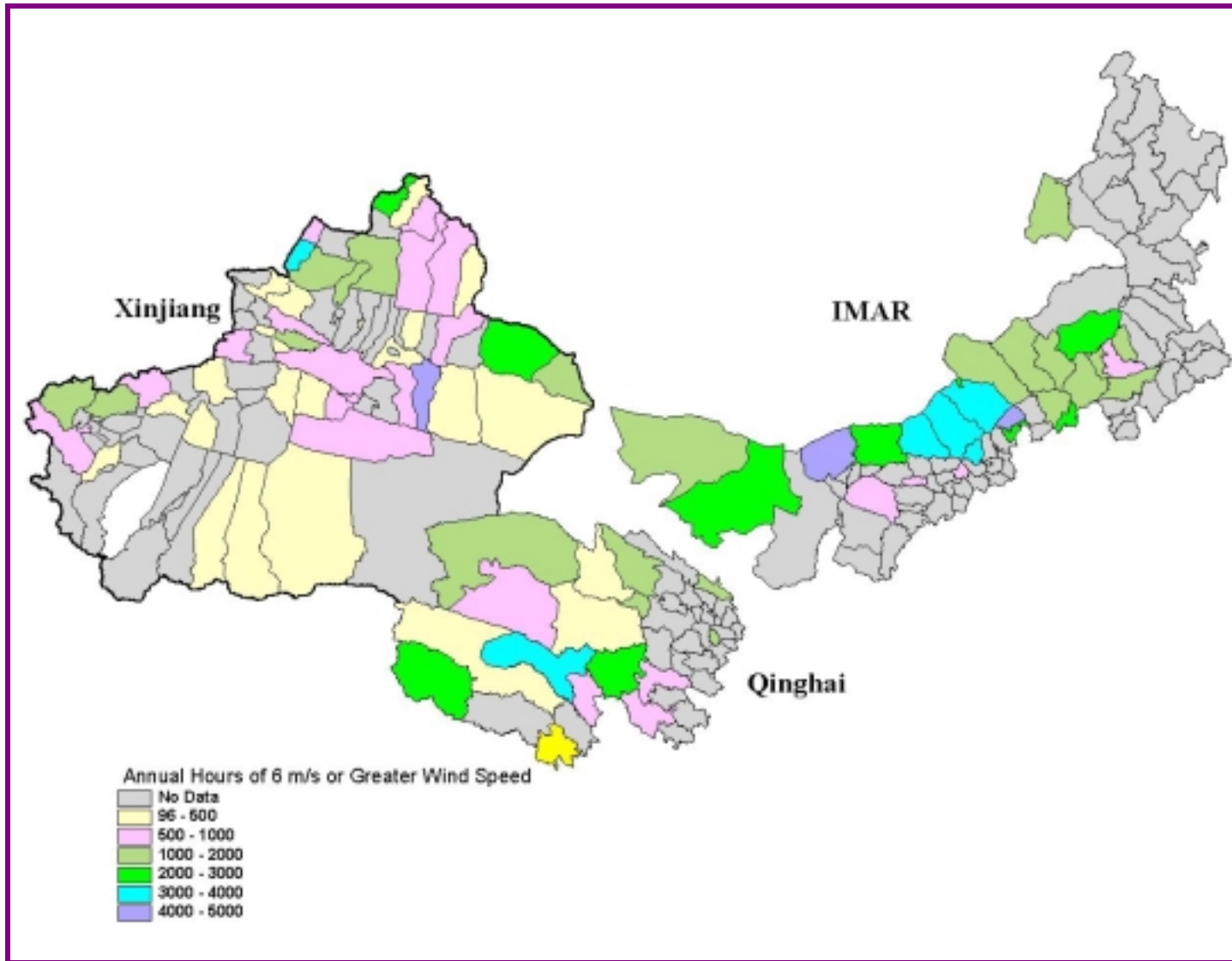

FIGURE 4-5: WIND RESOURCE DISTRIBUTION (WIND SPEED ≥ 6 M/S)IN QINGHAI, XINJIANG AND IMAR, CHINA

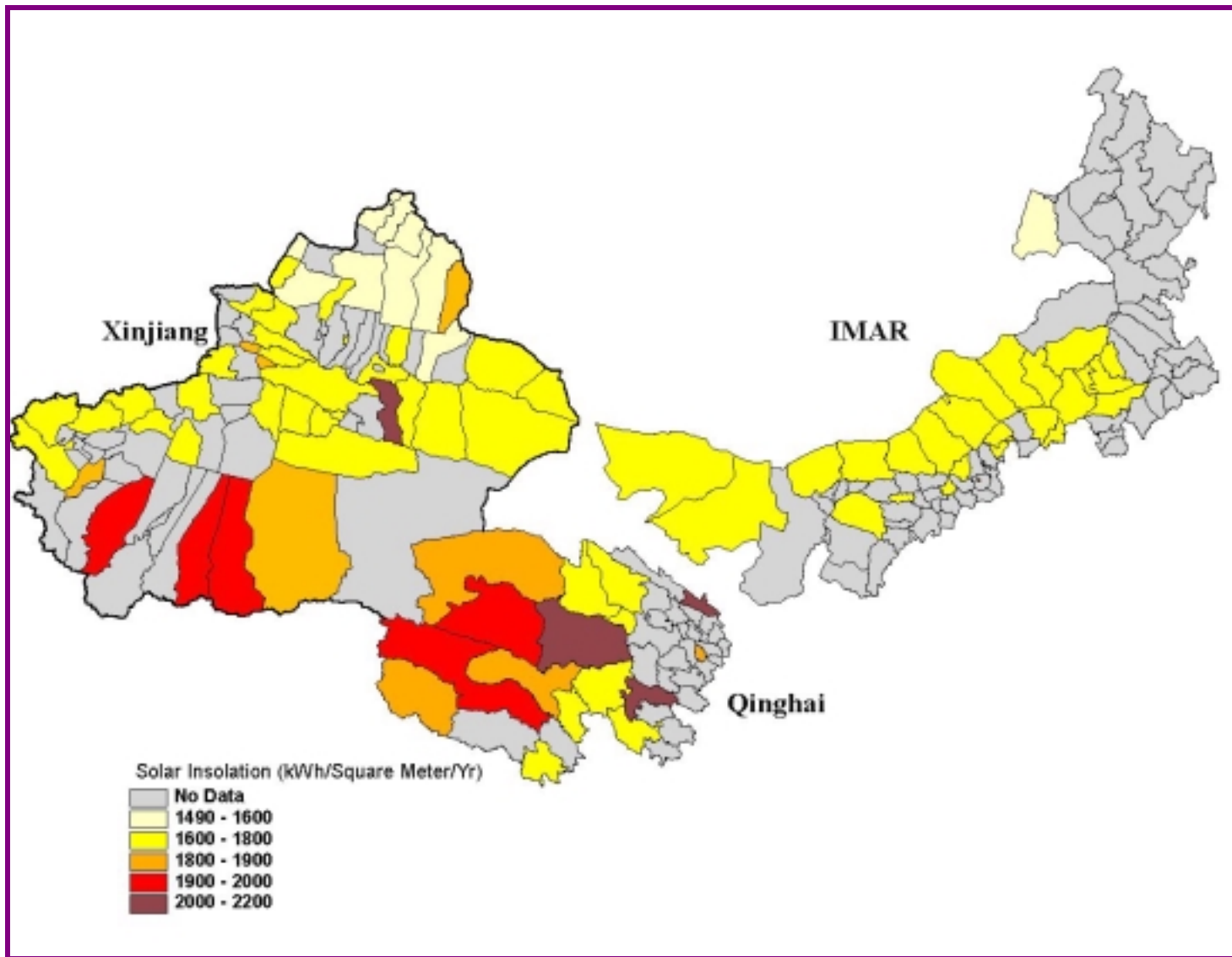

FIGURE 4-6: SOLAR RESOURCE DISTRIBUTION IN QINGHAI, XINJIANG AND IMAR, CHINA

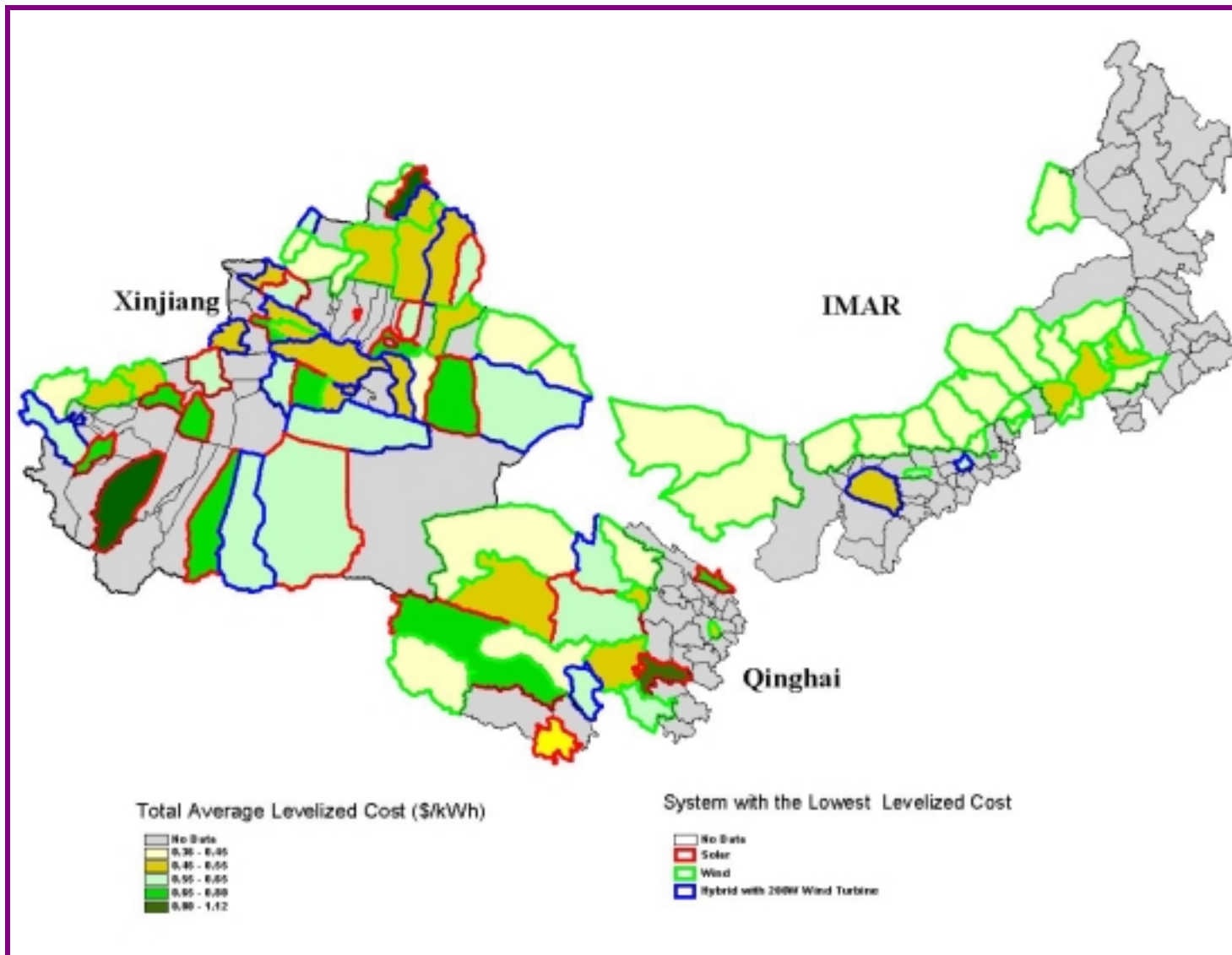

FIGURE 4-7: TOTAL AVERAGE LEVELIZED COST DISTRIBUTION AND THE SYSTEM WITH THE LOWEST LEVELIZED COST FOR SPECIFIC COUNTIES IN QINGHAI, XINJIANG AND IMAR, CHINA

5. MODELING OF SOCIO-ECONOMIC ASSESSMENT OF OFF-GRID RENEWABLE USERS

Findings from CEEP's resource assessment and levelized cost analysis point to a significant potential for renewable energy development in Western China. It is necessary next to identify social and economic needs for constraints to renewable energy use by rural households in the region. For this purpose, CEEP conducted a comprehensive socio-economic assessment in IMAR, Qinghai and Xinjiang. The goals of this assessment were to characterize rural energy users in Western China, to understand socio-economic conditions that affect their use of renewables, and to determine opportunities for and barriers to market development for rural renewable energy use in Western China. This chapter describes the methodology used in conducting the socio-economic assessment and its results.

5.1 Overview of the Socio-Economic Assessment Study

The socio-economic assessment contained four steps. The first was the design of a 59-question (some questions will derive to several sub-questions) survey. The second step involved a sampling design for selection of household participants in the survey. The third step was to administer the survey to the sample of households in each of the three provinces/regions. The sample survey included a total of 531 representative rural households. Fourth, a socio-economic statistical survey was designed for the county level (involving 22 counties spread over the three provinces/regions) and regional level (including IMAR, Qinghai and Xinjiang). These survey data were then coded and converted for use in SPSS — a statistical analysis software — for a descriptive analysis in order to help understand socio-economic conditions that affect the use of renewables in these regions. The conceptual framework of our socio-economic assessment study is illustrated in Figure 5-1.

FIGURE 5-1: CONCEPTUAL FRAMEWORK OF SOCIO-ECONOMIC ASSESSMENT STUDY

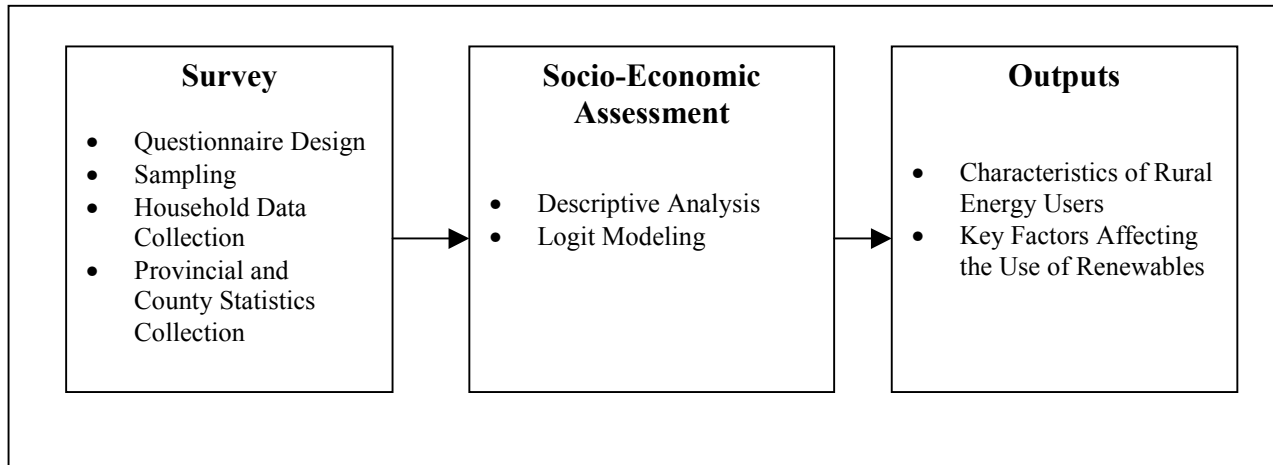

5.2 Rural Renewable Energy Survey

5.2.1 Survey Questionnaire

CEEP’s socio-economic survey was administrated at two levels — the micro-level (households) and macro-level (both counties and provinces/regions). A questionnaire was developed to gather original data on household energy use, socio-economic characteristics, and attitudes toward renewable energy. The household questionnaire includes four sections:

- general information about each household;
- status of household energy loads and fuel usage;
- detailed information on energy systems that the household was currently using;
- and household attitudes towards rural energy options in general and renewables in particular.

The household questionnaire instrument is provided in Appendix B.

In addition, CEEP’s socio-economic assessment include a survey of county and provincial/regional statistics. It concentrated on several areas:

- general demographic information;
- aggregate economic and financial statistics;
- household income levels and distribution;
- extent of rural electrification;
- current levels of use of renewable energy systems and forecasts of future levels;
- subsidies for renewables; and
- data on energy system companies and service stations.

The template for surveying county and provincial/regional level is included in the Appendix C.

5.2.2 Sampling Design

In order to ensure that the results of the survey were representative, a stratified sampling scheme was pursued. The selection of counties for sampling in each province/region reflected the diversity of their renewable energy resources and the range of income and family characteristics found in each province. The sampling of households in each county was also designed to reflect the wide range of energy users and their different characteristics. A diagram of the sampling design used for the household survey is shown in Figure 5-2.

FIGURE 5-2: DIAGRAM THE SAMPLING DESIGN USED FOR THE HOUSEHOLD SURVEY

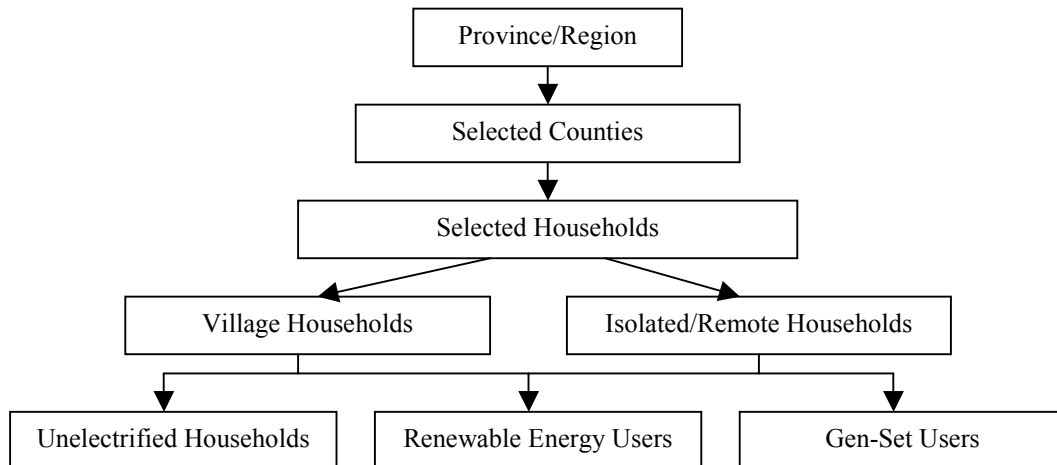

There were three categories of households surveyed: Unelectrified Households (UEHHs), Diesel/Gasoline Gen-Set Users (DG-SHHs), and Renewable Energy Users (REHHs). In each category, two geographically different household types constituted the strata: village households where users live together in small and remote households where users are alone and living far apart.

The summary of sampling design is listed in Table 5-1 below.

TABLE 5-1: SUMMARY OF SAMPLING DESIGN

	IMAR	Qinghai	Xinjiang
Counties Surveyed	11	6	5
Villages Sampled in Each County	5	4	4
UEHHs	30/10*	30/10	30/10
DG-SHHs	20/10	12/18	12/18
REHHs	100/30	40/30	40/30
Total	200	140	140

* The 30/10, entry means that 30 is the number of village households in the strata, while 10 is the number of remote households in the strata. This convention is applied in reporting sampling goods by household type in Table 5-1.

It's important to note that the actual samples were not obtained strictly according to the above design. Adjustments were made when initial survey data were reviewed. For example, after the IMAR survey was completed, we found that fewer UEHHs were available than expected, while REHHs were more frequent than expected. As a result, another 40 UEHHs were enlisted for participating in the IMAR survey. The final number of households surveyed in IMAR was 240 while 163 households were surveyed in Qinghai and another 128 in Xinjiang.

5.3 Data Preparation

Original survey data were sent to CEEP in electronic files (Excel format) by its China partners – the Chinese Academy of Sciences (IMAR) and the Ministry of

Agriculture (Qinghai and Xinjiang). Data for each household were recorded in CEEP's survey template.

Two steps were taken to convert raw data into a standard statistical format for analysis.

CEEP staff first created an automated Visual Basic program within Excel to extract data from individual household surveys and enter them on a central spreadsheet. The macro created a new spreadsheet and imported all individual household. As a result of running this program, all surveys were collated into a single work sheet named the Combined Work Sheet — taking the format of listing questions by rows and households by columns.

In a second step, the Combined Work Sheet was then formatted as a SPSS file so that statistical analyses could be performed. A series of descriptive and comparative statistical routines were run to generate profiles of Western China's rural energy users.

Prior to performing the descriptive and comparative analyses, procedures were performed to improve the interpretability of results. Household responses were scaled as ordinal, nominal and ratio variables in SPSS. Dichotomous responses (yes/no) were converted to numerical responses (1/2). Descriptive statistics were then developed for each class of data using standard functions in SPSS. The socio-economic assessment was completed with comparative statistics developed across regions and variables of interest.

The characteristics of rural energy users in Western China were identified in three steps. The first step was to establish reliable portraits of household composition, sources of income and expenditures. The next step was to create profiles of rural energy generation and utilization and distribution in the region. The last step was to characterize the attitudes of respondents toward renewable energy.

5.4 Descriptive and Comparative Statistics

5.4.1 General Household Characteristics

The household survey was administered in 11 counties of IMAR, 6 counties of Qinghai and 5 counties of Xingjiang. There were a total of 240, 163 and 128 respondents in IMAR, Qinghai and Xingjiang, respectively. The mean age of the respondents was 42.

Figure 5-3 shows the education level of household members in the three provinces. All household members interviewed for the survey in IMAR had some level of formal schooling. In Qinghai and Xinjiang 11 % and 3.9 % of household members, respectively, had not attended school. The highest educational level among household members contacted for the survey was senior high school level.

FIGURE 5-3: EDUCATION LEVEL OF HOUSEHOLD MEMBERS

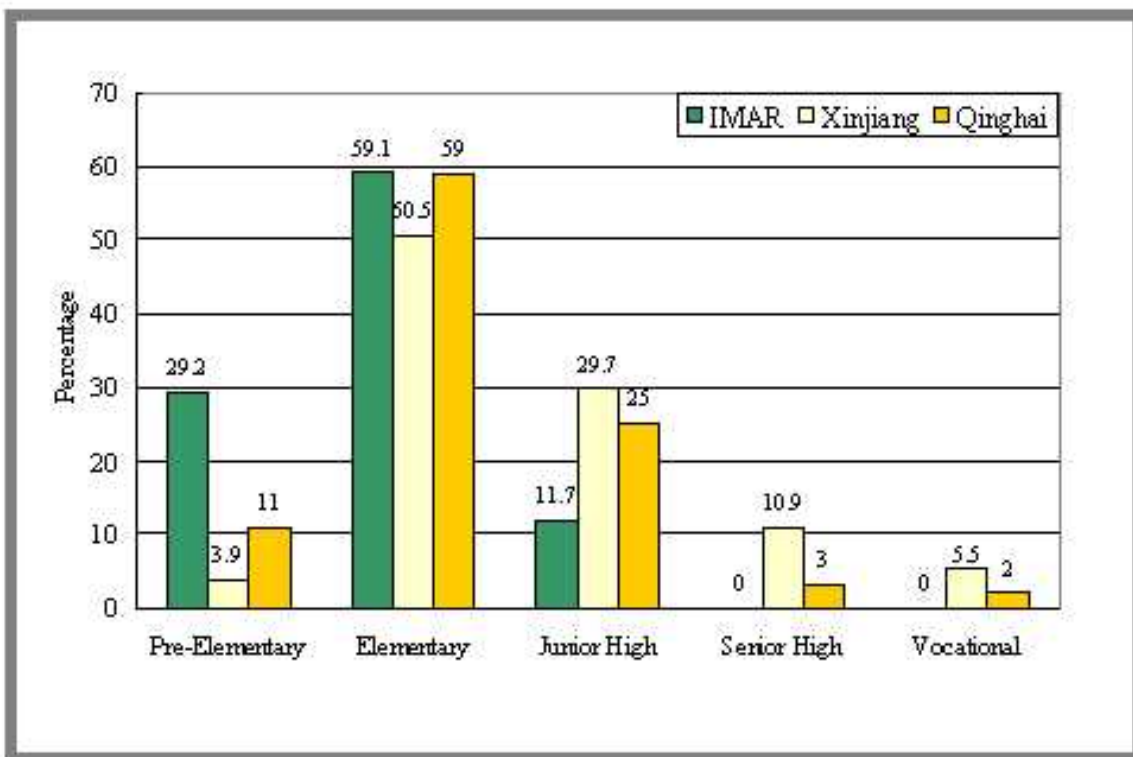

TABLE 5-2: IMAR, QINGHAI AND XINJIANG HOUSEHOLD PROFILE

	IMAR	Qinghai	Xinjiang
Average Household Size	5	7	6
Average Area of the House (m ²)	86	107	80
Household Annual Income (Yuan)	40,395	23,914	15,176
Household Annual Expenses (Yuan)			
Energy Related	656 (2.4%)	866 (5.5%)	1,114 (11.9 %)
Non-Energy Related	26,472 (97.6%)	14,950 (94.5%)	8,246 (88.1%)
Total Expenditures	27,128	15,816	9,360
Household Annual Savings (Yuan)	13,267	8,098	5,816
Per Cent of Income Saved	32.8 %	33.9 %	38.3 %

Table 5-2 shows the mean household composition, housing area, income and expenditure mix of the respondents. Respondents in IMAR tend to depend on livestock for income generation, while households in Qinghai and Xinjiang depend both on agriculture and non-agricultural sources of income earning activity. In Xinjiang, almost 12% of expenses are related to fuel consumption, while IMAR respondents spend a minimal amount (2.4%) on energy. In Qinghai, a modest 5.5 % of their total annual expenses. Around one third of the household annual income was saved.

5.4.2 Household Electricity Uses and Energy Systems

The survey provides some comprehensive data regarding rural energy supply and consumption patterns in Western China. Social conditions and preferences can be effectively gauged from the data.

The three provinces in the study are predominantly rural and are characterized by dispersed populations. The combination of these two factors has resulted in the large average distances that exist between the end user (in this case, a rural household) and the electric supply grid. The average distances to the grid are 21.5 km in IMAR, 23.3 km in Qinghai and 36.1 km in Xinjiang. The low per-capita consumption of energy and the dispersed nature of loads have act as disincentives to utilities to electrify these villages

from the grid. The only viable option is the installation and operation of decentralized energy systems compatible with the scale of household demand that exists in these rural areas. Energy systems that are commonly employed include photovoltaic panels, wind turbines, hybrid systems involving PV panels and wind turbines, and diesel generator sets.

TABLE 5-3: DISTRIBUTION OF GENERATION SYSTEMS BY PROVINCE

	IMAR	Qinghai	Xinjiang
Number of Household with Wind System	187 (77.9 %)	48 (29.4 %)	38 (29.7 %)
Number of Household with PV System	10 (4.2 %)	96 (58.9 %)	50 (39.1 %)
Number of Household with Gen-Sets System	16 (6.7 %)	none	13 (10.2 %)

The capacity of the PV systems ranges from below 30W to above 100W. From the survey it was learned that installed PV systems had capacities below 30W in Qinghai. In Xinjiang three-fourths of the PV systems had capacities below 30W and the remaining 25% had capacities between 30-100W. In the case of IMAR, 60% of the PV systems were rated between 30-100W, 20% were rated above 100W, and only 20% were below 30W. From the survey, it was determined that 97% of the wind turbines in IMAR are rated at 100W while only 30% are 300W. In Xinjiang, 64% are rated at 100W, 15% at 200W, 23% at 500W, and 8% at 600W. Tables 5-4 and 5-5 present these results. Survey data regarding the diesel generator system estimates that for IMAR province, 63% of the units are rated at 400W, 31% at 450W and only 6% have a capacity of 600W. Survey data regarding diesel generator sets for the provinces of Qinghai and Xinjiang are not available.

TABLE 5-4: PV SYSTEM PROFILES

	IMAR	Qinghai	Xinjiang
Size of PV System Distribution	< 30 W– 20 %; 30-100 W– 60%; > 100 W– 20 %	<30 W–100 %	< 30 W–74 %; 30-100 W–26 %
Average Capital Cost (Yuan)	3760	1504	1713
Average Annual Maintenance Cost (Yuan)	20	50	30
Expected Lifetime (Years)	15	No data	No data

Local conditions such as geography and social preferences vary considerably for the three provinces. Social and economic conditions are reflected in the intended end-use of energy. Although survey did not provide end-use data for IMAR, in Qinghai TV was highest on the priorities at 77%, refrigerator at 12%, washer at 7.5% and tape recorder at 3.5%. In Xinjiang 37% were interested in energy systems to power a TV, 17% to run a washer, 14% to power a refrigerator, 8.6% to operate a tape recorder and 10.4% to operate videocassette equipment.

TABLE 5-5: WIND SYSTEM PROFILES

	IMAR	Qinghai	Xinjiang
Size of Wind System Distribution	100 W –97 %; 300 W- 3 %	100 W- 54 %; 200 W –15%; 500 W – 23%; 600 W – 8 %	100 W – 64 %; 150 W – 36 %
Average Capital Cost (Yuan)	1,195	1,449	1,645
Average Annual Maintenance Cost (Yuan)	100	50	60
Expected Lifetime (Years)	10	6	10

5.5 Socio-Economic Conditions Affecting Attitudes Toward Renewable Energy

Centralized systems for transmitting electricity through long transmission lines to rural areas have been applied widely in the industrial world. The experiences of the U.S. and other industrialized countries with centralized energy systems in rural areas have been emulated by the developing world. The rationale being that such centralized systems would enhance the quality of rural lives. However, from the household survey it would appear that, many of the residents of IMAR, Xinjiang, and Qinghai disagree with this premise. According to the surveys of households in these rural areas, they prefer decentralized off-grid energy systems in their houses.

Since the availability of renewable energy resources determines the energy output of renewable energy systems, some have raised concerns that energy shortages are inevitable when renewable sources like solar and wind are not readily abundant. Respondents from Qinghai and Xinjiang provinces suggest that rural users see the

question of reliability differently. Although data on this question were not gathered for IMAR, residents in Qinghai indicated that 69% think PV systems are reliable, 26% think that PV/Wind Hybrid systems are reliable, and 4% think that wind stand-alone systems are reliable. In Xinjiang province, 72% of the respondents thought that PV/Wind Hybrid systems are reliable, 16% felt that PV stand alone systems are reliable, and 11% thought wind stand alone systems are reliable. In brief, renewable energy systems, in the appropriate configurations, are regarded by rural users in Western China as reliable.

Meeting energy demands through a decentralized stand-alone renewable energy systems is positively regarded by households in our sample. In Qinghai and Xinjiang Provinces, more than 90% of rural respondents expressed a willingness to pay for reliable renewable energy systems. Over 53% of the respondents from IMAR indicated that they would be willing to spend 10,000 Yuan (\$1209) for such systems. Almost 44% of the IMAR respondents said that they were willing to pay between 10,000 (\$1209) to 20,000 (\$2418) Yuan, and more than 3% were willing to pay more than 20,000 (\$2418)Yuan for stand alone renewable energy systems.

None of the respondents from the sample preferred to buy gen-set or other energy systems that require fossil fuel. This is attributable to the high delivered fuel cost and maintenance requirements of gen-set which, in the perspective of rural energy users, makes them less reliable than renewable energy systems.

5.6 Conclusion

According to the rural populations surveyed in IMAR, Xinjiang, and Qinghai, capital cost, equipment quality, and after-sale services are the most important criteria affecting their purchasing decisions regarding renewable energy systems. Maintenance and service issues, especially, battery malfunctioning and short battery life, affect attitudes toward renewable energy systems. Potential improvements in batteries, market development strategies that address after-sale services, and policy interventions to improve system affordability would appear to be key actions for expanding the renewable

energy market in Western China. These actions would encourage positive attitudes toward renewable energy options and improve the socio-economic conditions of rural life.

6. MARKET POTENTIAL AND SIZE OF RURAL RENEWABLE ENERGY SYSTEMS IN WESTERN CHINA

This Chapter presents CEEP's estimate of future market for rural renewable energy use in Western China. CEEP's estimate has calculated in two steps. The first step was to develop a logistical regression model for the identification of key predictors of the future users of different renewable energy systems in Western China. Then, an estimation of the market size for these systems was developed using the regression model and county and provincial statistics.

6.1 Creation of a Logistic Regression Model

In addition to our descriptive analysis, another major task of the socio-economic assessment involved an estimate of the future market for rural renewable energy systems in Western China. This required us to first identify the factors that affect the purchase of renewable energy systems, i.e. we had to determine which types of customers would likely become potential purchasers of renewable energy systems. The "potential renewable energy purchaser" is considered a categorical response variable and takes one of only two values: yes or no (with an assigned value of 1 or 0).

Since the least squares regression method would often result in predicted values that are either less than 0 or greater than 1, values that cannot possibly occur in our prediction, we need to use an alternative estimation procedure approach. The logistic regression model (or LRM) was created to predict the probability of a particular categorical response for a given set of non-categorical independent variables.

LRMs are interpreted using the odds ratio, which represents the probability of a success compared to the probability of failure. By using a mathematical method called maximum likelihood estimation, LRMs can be created to predict the natural logarithm of the odds ratio. From sample data, one can create the following model:

$$\ln(\text{EOR})=a_0+ a_1X_1+ a_2X_2+\dots+ a_kX_k$$

here,

EOR = estimated odds ratio;

a_i = regression coefficients;

X_i = independent variables.

Once the LRM has been fit to a set of data, one can calculate the estimated odds ratio, or EOR, by raising the constant e to the power equal to the natural logarithm of the estimated odds ratio. For this purpose,

$$\text{EOR} = e^{\ln(\text{EOR})}$$

The probability of success can be estimated after having the EOR:

$$\text{Probability of success} = \text{EOR}/(1+\text{EOR}).$$

A hypothetical example can illustrate the method. Let us suppose that the logistical regression model has identified, say, household income, as one of significant contributing factors to predict the potential purchaser of a PV system. Furthermore, the odds ratio estimation has indicated that a household whose annual income is equal to or above 3000 Yuan is more likely to purchase a PV system than a household whose annual income is below 3000 Yuan (the independent variable, income, is coded here as yes (or 1) refers to income \geq 3000 Yuan and no (or 0) refers to income $<$ 3000 Yuan). If the estimated odds ratio (or EOR) of yes is 2, the estimated probability of using a PV system would be 0.66 (i.e., $\text{EOR}/(1+\text{EOR})$). This means that the odds that a household with a 3000 Yuan or higher annual income would purchase a PV system are 2 to 1 and that 66% of such households could be expected to purchase a PV system.

The above discussion provides the conceptual description of creating LRMs and estimating the probability of a favorable purchase decision based on an array of socio-economic factors. The creation of LRMs and estimates of purchase probabilities can be

done directly by using a statistical software such as SPSS, SAS or others. SAS was used for this study.

6.2 Logistical Regression Modeling for the Determination of Key Predictors of Rural Renewable Energy Purchasers

We utilized SAS (Version 6.0 operating on a UNIX platform) to develop our logistical regression models. Despite our goal of having a large pool of sample data to build our model from, we faced the reality that many of the surveyed households did not complete entire questionnaires, thus leading to a reduced number of data points. There were only a total of 100 completed samples used in our model due to this data limitation.

6.2.1 Variables for Modeling

- *Response Variables*

Since there are different market segments for different types and sizes of renewable energy systems in rural Western China, they need to be identified separately. Therefore, we needed to not only estimate factors that lead a household to become a user of a PV panel, a wind turbine or a PV/wind hybrid system, but also to determine whether or not a household would prefer a larger or smaller renewable energy system (by larger system, we mean a system that has a size larger than 100W wind or/and 50W_p PV). In this view, it was necessary to know whether a household would be willing to pay 3,000 Yuan or more with possible loan assistance for a large system.

For the above reasons, we identified five response variables for our logistical regression modeling. These five variables are listed in Table 6-1.

TABLE 6-1: RESPONSE VARIABLES

Variable Name	Representation	Code
PV	Potential PV users?	0='no' 1='yes'
WIND	Potential wind users?	0='no' 1='yes'
HYBRID	Potential hybrid users?	0='no' 1='yes'
LGSYS	Potential large system user? (>100w wind or/and >50w _p pv)	0='no' 1='yes'
WTPLGELN	Willing to pay 3,000 Yuan or more for a large system (with available loan assistance)?	0='no' 1='yes'

- *Explanatory Variables*

Since our household survey consists of hundreds of questions, we first examined statistical relations between the many possible variables and our categorical response variables. Our selection of explanatory variables for logistical regression modeling was based on three criteria: high correlation with response variables, few missing observations, and general theoretical reasoning. Regarding this last items, the economics of “willingness to use/pay” is well-established (Michael Parkin, Microeconomics 2nd Edition). We selected variables that met statistical criteria and generally conformed with the theory of demand in economics.

To identify our explanatory variables, we performed a correlation analysis to decide which independent variables correlated with each of the five response variables. We selected those variables that had moderate (0.3-0.6) to high (0.7-1.0) value of correlation coefficients and those that were at a 0.05 level of statistical significance (representing $p > 95\%$). We eliminated from further consideration those variables that did not meet the above criteria. We then looked at the number of observations for the remaining variables and dropped those that had more than 3 missing values in all observations (i.e., less than 97 of 100 observations for each variable had valid values). The reason for eliminating a variable with several missing values is twofold: first, inclusion of such variables would require reduced observations for other response variables or explanatory variables; second, variables with several missing values are less statistically reliable for estimation purposes.

After the correlation analysis, we identified a total of 13 explanatory variables for our modeling. All have theoretical justification for use. Further, the signs on the correlation conform with the theoretically effected direction of influence (e.g., income was positively correlated with willingness to purchase, suggesting that households with higher income and more likely to purchase larger system).

Since response variables only have two possible values (0 or 1), explanatory variables should also have two values (0 or 1). To change the existing explanatory variables from numerical to categorical variables, we created a series of dummy variables. These variables are presented in Table 6-2. As can be observed by inspection of this table, several numerical variables were modeled as multiple dichotomous variables. For example, to determine with greater precision the effect of agricultural income on willingness to use/pay, we modeled this variable as two dichotomous variables – whether a household is in the low agricultural income or middle agricultural income category. The constant term in the logistic regression captures the effect of high agricultural income. In this regard, we used a standard procedure for modeling the effect of numerical variables on categorical responses.

TABLE 6-2: EXPLANATORY VARIABLES

Variable Name	Representation	Code
1. ABLEPAY	ability to pay over 3000 Yuan for renewables	0='no' 1='yes'
2. AGEGRP1	respondent' age <40 years old	0='no' 1='yes'
3. AGEGRP2	40 years old <=respondent's age<50 years old	0='no' 1='yes'
4. AGICMLW	household annual agricultural income<5000 Yuan	0='no' 1='yes'
5. AGICMMD	5000 Yuan<=household annual agricultural income<10000 Yuan	0='no' 1='yes'
6. NOEDU	no any education	0='no' 1='yes'
7. ELMTSCHL	Elementary school	0='no' 1='yes'
8. MIDSCHL	middle school	0='no' 1='yes'
9. FUELEPLW	annual fuel expenses<600 Yuan	0='no' 1='yes'
10. FUELEPMD	600 Yuan<=annual fuel expenses<1000 Yuan	0='no' 1='yes'
11. HHSIZE	household size<5 people	0='no' 1='yes'
12. HSAREASM	house area<70 m ²	0='no' 1='yes'
13. HSAREAMD	70 m ² <=house area<100 m ²	0='no' 1='yes'
14. KM_SHORT	distance to the nearest grid < 10 km	0='no' 1='yes'
15. KM_MID	10 km<=distance to the nearest grid<60 km	0='no' 1='yes'
16. NONAGLW	annual non-agricultural income < 1000 Yuan	0='no' 1='yes'
17. NONAGMD	1000 Yuan<=annual non-agricultural income<5000 Yuan	0='no' 1='yes'
18. PAY1	pay cash for renewable energy systems	0='no' 1='yes'
19. PAY2	buy renewable energy systems with loan	0='no' 1='yes'
20. TOTAEPPLW	household annual expenses < 6000 Yuan	0='no' 1='yes'
21. TOTAEPMD	6000 Yuan<= household annual expense < 11000 Yuan	0='no' 1='yes'
22. TOTAIMLW	household annual income <10000 Yuan	0='no' 1='yes'
23. TOTAIMMD	10000 Yuan<=household annual income <15000 Yuan	0='no' 1='yes'

6.2.2 Model Building

We performed our logistical regression analysis using SAS. Since we had decided to evaluate 5 different response variables, five separate models were with each of these five variables as the dependent variable and the 13 explanatory variables (23 dummy variables) as independent variables. Two techniques were used when building the models: exclusion of the intercept and use of stepwise regression.

With the realistic response curves of logistical regression, the probability of a success should fall between 0 and 1 for all possible X-values. We, therefore, instructed SAS to exclude the intercept in these models because the existence of non-zero intercepts would lead to response curves not falling in the area where Y-values are always between 0 and 1 for all X-values.

In addition, the independent variables are not truly “independent” with one another in many occasions. They maybe correlated with each other. If these correlations are moderate to high (e.g., 0.5 or higher), then the regression results would be greatly affected. For example, the coefficient for independent variable B tells us its unique contribution to the dependent variable A. If B is the only variable in the regression, there is no problem. But, if another independent variable C is added to the model and B and C are highly correlated, then the unique contribution of B on A will be changed. To avoid this problem, we used a stepwise regression technique. The goal of a stepwise technique is to take a set of independent variables and put them into a regression model one at a time in a specified manner until all variables have been added or until a specified criterion has been met. The criterion is usually one of statistical significance such as: there are no more regressors that would be significant if they are added, or, the additional r^2 to be gained by entering the next regressor is too small to justify its inclusion.

SAS allows five different stepwise techniques, i.e., FORWARD, BACKWARD, STEPWISE, MAXR and MINR. In our modeling, we used the STEPWISE technique in

which a regression starts with the best single regressor to be included in the equation, then adds the next best one, and then the next best, etc. All variables added to the model were checked again to see if they remain significant after the new variable had been entered. The results of our logistical regression analysis are provided below.

6.2.3 Modeling Results

- *Wind Users*

The results of predicting whether or not a household is a potential small wind turbine user are presented in Table 6-3.

Response Variable: WIND (Potential wind system user? 0="no", 1="yes")

Number of Observations: 100

TABLE 6-3: ANALYSIS OF MAXIMUM LIKELIHOOD ESTIMATES :WIND USERS

Variable	Parameter Estimate	Standard Error	Pr >	Odds Ratio
ELMTSCHL	2.1533	0.7979	0.0070	8.613
FUELEPMD	-2.1568	0.8405	0.0103	0.116
HHSIZE	2.6335	0.8627	0.0023	13.922
NONAGLW	2.2348	1.0627	0.0355	9.344
NONAGMD	1.8251	0.8716	0.0362	6.204

Association of Predicted Probabilities and Observed Responses

Concordant = 88.4% Somers' D = 0.801

Discordant = 8.2% **Gamma = 0.829**

Tied = 3.4% c = 0.90

Here,

ELMTSCHL = elementary school education (0='no' and 1='yes')

FUELEPMD = intermediate level of household annual fuel expenses (i.e. between 600 and 1,000 Yuan) (0='no' and 1='yes')

HHSIZE = household members are less than 5 (0='no' and 1='yes')

NONAGLW = low level of annual non-agricultural income (less than 1000 Yuan)
(0='no' and 1='yes')

NONAGMD = intermediate level of non-agricultural income (between 1000 and 5000 Yuan) (0='no' and 1='yes')

This model shows that a household is likelihood of being a small wind system is determined by the user's education status, household size, annual fuel costs and its annual non-agricultural income. The positive coefficients of ELEM SCHL, HHSIZE, NONAGLW and NONAGMD indicate that the estimated odds of using a wind turbine are higher for a user who has an elementary education only and lives in a house which has fewer people (less than 5) and who has low to moderate nonagricultural income (below 5,000 Yuan annually). The negative coefficient of FUELEPMD means that the estimated odds for using a wind system are lower when the household's annual fuel expenses are moderate (between 600 and 1,000 Yuan) than when the household has low fuel costs (less than 600 Yuan). This can be interpreted to mean that low-income household are more likely to buy small wind turbines, while those with higher incomes have greater energy needs which are better satisfied with other, larger energy supply systems.

The odds ratios (by calculating the antilog of the coefficient we obtain the odds ratio, as discussed above) can be interpreted to mean that the estimated odds of using a small wind turbine would increase by 12.9 times, 7.6 times, 8.3 times, and 5.2 times, respectively, when household size is smaller (less than 5 members), the user only has elementary school education, or when the household annual non-agricultural income is below 5,000 Yuan. However, odds for using a wind turbine would decrease 88.4% (i.e., $1 - 0.116 = 0.884$) when household annual fuel costs are moderate (between 600 and 1,000 Yuan), compared to the case when fuel costs are low (less than 1000 Yuan).

It should be mentioned that "ability to pay" variable were not significant in the case of small wind turbines. This can be explained by the existence of subsidy programs

to assist rural households in acquiring small wind systems (mainly in IMAR). These programs have effectively made small wind systems available to the bulk of rural households and, therefore, few respondents believed that they were unable to purchase them.

- *PV Users*

The results of predicting whether or not a household is a potential PV user are presented in Table 6-4.

Response Variable: PV (Potential PV system user? 0='no', 1='yes')

Number of Observations: 99 (one missing value)

TABLE 6-4: ANALYSIS OF MAXIMUM LIKELIHOOD ESTIMATES :PV USERS

Variable	Parameter Estimate	Standard Error	Pr>	Odds Ratio
ABLEPAY	3.0749	1.3532	0.0231	21.648
FUELEPLW	3.3767	1.0349	0.0011	29.274
FUELEPMD	3.5827	1.1516	0.0019	35.970
HSAREASM	6.1945	1.4451	0.0001	490.056
HSAREAMD	3.7987	1.0656	0.0004	44.645
NONAGLW	-3.1685	1.0431	0.0024	0.042
NONAGMD	-2.0700	0.8310	0.0127	0.126
PAY1	-3.8774	1.4180	0.0062	0.021

Association of Predicted Probabilities and Observed Responses

Concordant = 94.1% Somers' D = 0.896

Discordant = 4.6% **Gamma = 0.907**

Tied = 1.3% c = 0.948

Here,

ABLEPAY = ability to pay 3,000 Yuan or more for renewables (0='no' and 1='yes')

FUELEPLW = low level of household annual expenditures on fuels (less than 600 Yuan) (0='no' and 1='yes')

FUELEPMD = intermediate level of household annual expenditures on fuels (between 600 and 1,000 Yuan) (0='no' and 1='yes')

HSAREALW = house area below 70 m² (0='no' and 1='yes')

HSAREAMD = house area between 70-100 m² (0='no' and 1='yes')

NONAGLW = low level of annual non-agricultural income (less than 1000 Yuan) (0='no' and 1='yes')

NONAGMD = intermediate level of non-agricultural income (between 1000 and 5000 Yuan) (0='no' and 1='yes')

PAY1 = able to make a single payment for renewable energy systems (0='no' and 1='yes')

The results indicate that the likelihood of a household becoming a PV depends on the user's financial capability, his/her payment preference, housing size, household annual fuel expenses, as well as annual non-agricultural income. The regression results show that the odds for buying a PV system would be higher when the household is capable of paying 3,000 Yuan or more and when housing size is relatively small (less than 100 m²). The odds are also higher when a household's current fuel expenses are low to moderate in level (less than 1,000 Yuan yearly) — an indication that the household has the potential to spend more on energy given its current relatively low fuel costs. However, the odds of buying a PV system would be lower when a household's annual non-agricultural income is less than 5,000 Yuan and when households have to pay cash to buy the system. These results underscore the preference for small PV systems in Xinjiang and Qinghai where incomes are quiet low,. If this market is to be expanded, loan services will have to be expanded to serve the needs of low-income users.

- *Hybrid Users*

The results for PV/wind hybrid systems are presented in Table 6-5.

Response Variable: HYBRID (Potential PV/wind hybrid user? 0="no", 1="yes")

Number of Observations: 99 (one missing value)

TABLE 6-5: ANALYSIS OF MAXIMUM LIKELIHOOD ESTIMATES :HYBRID USERS

Variable	Parameter Estimate	Standard Error	Pr>	Odds Ratio
AGEGRP2	1.5979	0.6001	0.0078	4.942
AGICMLW	-2.7232	0.8513	0.0014	0.066
FUELEPLW	4.0334	1.2384	0.0011	56.452
FUELEPMD	3.8271	1.1702	0.0011	45.931
PAY1	-2.8281	1.0824	0.0090	0.059

Association of Predicted Probabilities and Observed Responses

Concordant = 86.1% Somers' D = 0.735

Discordant = 12.6% **Gamma = 0.745**

Tied = 1.3% c = 0.867

Here,

AGEGRP2 = user's age between 40 and 50 years old (0='no' and 1='yes')

AGICMLW = annual agricultural income less than 5,000 Yuan (0='no' and 1='yes')

FUELEPLW = low level of annual household expenditures on fuels (i.e. less than 600 Yuan) (0='no' and 1='yes')

FUELEPMD = intermediate level of household annual expenditures on fuels (i.e. between 600 and 1,000 Yuan) (0='no' and 1='yes')

PAY1 = able to make single cash payment for renewable energy systems (0='no' and 1='yes')

The results indicate that the probability of a household becoming a PV/wind hybrid user is based upon the user's age, financial status, household annual fuel costs and agricultural income. The regression results indicate that the odds for using a hybrid system would be higher when a household's current fuel expenses are low to moderate (less than 1,000 Yuan yearly) — an indication that household currently has modest fuel expenditures and thus maybe able to spend more on fuels. The results also show that

people in the age group between 40 and 50 years old are more likely to use a hybrid system than people in other age groups. The odds of hybrid system being preferred are lower when a household does not have access to loan assistance and when its annual agricultural income is below 5,000 Yuan.

Overall, these results are consistent with those for wind-only and PV-only systems. It would appear that the distinguishing factors for likely hybrid users are age and income: older households with moderate or higher incomes tend to prefer hybrid systems. This can be expected both because older households would tend to have more income and because they also have prior experience with a renewable energy system and all prepared to handle the more complicated hybrid system’s operating requirements.

- *Large System Users*

The results of predicting a household’s willingness to purchase a system that is larger than 100W wind and/or 50W_p PV are given in Table 6-6.

Response Variable: LGSYS (Potential large system user? 0=’no’, 1=’yes’)

Number of Observations: 99 (one missing value)

TABLE 6-6: ANALYSIS OF MAXIMUM LIKELIHOOD ESTIMATES :LARGE SYSTEM USERS

Variable	Parameter Estimate	Standard Error	Pr>	Odds Ratio
AGICMMD	1.6810	0.6705	0.0122	5.371
FUELEPLW	4.3054	1.2320	0.0005	74.098
FUELEPMD	4.6331	1.3723	0.0007	102.827
HSAREASM	-3.8527	0.9319	0.0001	0.021
HSAREAMD	-2.3240	0.8338	0.0053	0.098
PAY1	-2.4931	1.2278	0.0423	0.083
PAY2	4.0212	1.5445	0.0092	55.766

Association of Predicted Probabilities and Observed Responses

Concordant = 92.5.1% Somers' D = 0.864

Discordant = 6.2% **Gamma = 0.875**

Tied = 1.3% c = 0.93

Here,

AGICMMD = annual agricultural income between 5,000 and 10,000 Yuan
(0='no' and 1='yes')

FUELEPLW = low level of household annual fuel expenditures (i.e. less than 600 Yuan) (0='no' and 1='yes')

FUELEPMD = intermediate level of household annual fuel expenditures (i.e. between 600 and 1,000 Yuan) (0='no' and 1='yes')

HSAREALW = house area below 70 m² (0='no' and 1='yes')

HSAREAMD = house area between 70 and 100 m² (0='no' and 1='yes')

PAY1 = able to make a single cash payment for renewable energy systems
(0='no' and 1='yes')

PAY2 = need loan for assistance for purchasing renewable energy systems
(0='no' and 1='yes')

The results here show that the probability of a household buying a large wind or PV system is determined by its financial capacity, housing size, household annual fuel costs and household agricultural income. The regression results indicate that a household is more likely to purchase a large renewable energy system if the household annual agricultural income is above 5,000 Yuan and loan assistance for purchasing a system is available. The odds would also be higher if a household's current fuel expenses are low to moderate (less than 1,000 Yuan yearly). But, the odds of purchasing a large system would be lower when the size of the home is relatively small (less than 100 m²) and when a household has to rely on cash for the purchase.

Again, these results are consistent with those for other user categories. Large system users tend to have relatively higher incomes., larger homes and modest current fuel cost. These households, however, will need loan services to purchase large wind or PV systems.

5. Willingness to Take a Loan for Purchasing Large Systems

Predicting if a household is willing to use a loan to pay 3,000 Yuan or more (through a loan) to buy a system larger than 100W wind or/and 50W_p PV involves factors that are consistent with our finding for other user categories (see Table 6-7).

Response Variable: WTPLGELN (willing to seek a loan over 3,000 Yuan for a large system? 0='no', 1='yes')

Number of Observations: 99 (one missing value)

TABLE 6-7: MAXIMUM LIKELIHOOD ESTIMATES (WILLINGNESS TO SEEK A LOAN TO PURCHASE A LARGE SYSTEM WITH LOAN)

Variable	Parameter Estimate	Standard Error	Pr>	Odds Ratio
ABLEPAY	-6.0158	1.5109	0.0001	0.002
AGICMLW	3.0006	0.8524	0.0004	20.098
FUELEPLW	-3.5589	0.9289	0.0001	0.028
FUELEPMD	-2.6489	0.7854	0.0007	0.071
HHSIZE	1.8586	0.7461	0.0127	6.415
TOTAEPLW	3.1503	1.0384	0.0024	23.343

Association of Predicted Probabilities and Observed Responses

Concordant = 94.3% Somers' D = 0.904

Discordant = 4.0% Gamma = 0.919

Tied = 1.7% c = 0.952

Here,

ABLEPAY = able to pay 3,000 Yuan or more for renewables (0='no' and 1='yes')

AGICMLW = annual agricultural income below 5,000 Yuan (0='no' and 1='yes')

FUELEPLW = low level of household annual fuel expenditures (i.e. less than 600 Yuan) (0='no' and 1='yes')

FUELEPMD = intermediate level of household annual fuel expenditures (i.e. between 600 and 1,000 Yuan) (0='no' and 1='yes')

HHSIZE = number of household members is less than 5 (0='no' and 1='yes')

TOTAEPLW = low level of household annual expenses (less than 6,000 Yuan)
(0='no' and 1='yes')

The above results show that the decision concerning whether or not a household is willing to seek a loan over 3,000 Yuan to buy a large system is determined by household's financial capacity, its total annual expenses, its current fuel costs, its annual agricultural income, as well as household size. The regression results reveal that a household is willing to use a loan of 3,000 Yuan or more to buy a larger renewable energy system (i.e., one larger than 100W wind and/or 50W_p PV) if the household's annual agricultural income and its annual total expenses are low (below 5,000 and 6,000 Yuan, respectively) — indications of the household's current situation being one of weak purchasing power. Moreover, a household is more likely to use a loan to purchase the system when its size is relatively small (5 people or less) — indicating that the household probably does not have enough income because it has fewer income earners. However, the odds for using a loan to buy a large system would be lower if a household has the financial ability to buy the system with cash. The odds would be also lower if the household's current fuel costs are modest (less than 1,000 Yuan) because the household may not need a loan for a renewable energy system when it is possible for the household to allocate more money from its current budget to the energy use. The ABLEPAY variable, by its negative sign, indicates that higher income households would prefer to pay cash than request a loan.

6.3 Results of Logistical Regression Analysis

Results of our logistical regression analysis suggest that three general factors — household financial status (annual income versus annual expenses), household size, and the housing area — are key predictors of whether a household would be favorably disposed to acquiring a renewable energy system.

For households with above average incomes (by Western China's standards) and have the ability to pay 3,000 Yuan or more for a renewable energy system, paying in cash is preferred. But, the odds of buying more expensive wind-PV or a hybrid systems grows when loan assistance is available. In the absence of loan assistance, these households are also less likely to buy systems that are larger than 100W wind or/and 50W_p PV. Households interest in a hybrid and large-scale systems (more than 100W wind or 50W_p PV), increases when current fuel costs are modest (less than 1,000 Yuan per year). This is because households have the potential to spend more on energy service.

Households with modest incomes (less than 5,000 Yuan) and low annual expenses are more likely to be wind system users in the IMAR and small PV (less than 50 W_p) users in Xinjiang and Qinghai. Additionally, these households favor the use of loans to buy renewable energy systems, especially ones that is larger than 100W wind or 50W_p PV.

Household with modest homes (less than 100m²) are more likely to buy small PV systems. Additionally, for those households with less than 5 people living in the home, acquiring a system that is larger than 100W wind or 50W_p PV is unlikely unless loan assistance is available.

6.4 Statistical Robustness of the Model

Finally, the statistical quality of our modeling can be evaluated by an inspection of the Somers'D, Gamma, Tau-b and c and measures associated with the logit regression. All of these statistics are measurements of association of predicted and observed responses. The magnitude of these values indicates the strength of the association. The values of each statistic should fall between -1 and 1 (negative versus positive relationship). The larger the absolute value, the stronger the relationship. In our logistical regression models, all of these values are close to 1, indicating very strong relationships between predicted probabilities and observed responses.

6.5 Prediction of the Potential Size of the Renewable Energy Market in Western China

Logistic regression models (LRM) can be used to identify specific factors that affect rural households' willingness to use renewable energy systems. Through statistically robust LRMs, we can determine the explanatory variables that offer accurate estimates of household's willingness to acquire renewable energy technology. These variables are now used as prediction factors to determine the potential size of rural renewable energy markets in Western China. To estimate the size of renewable energy markets by province, we combine the parameters of our LRMs with province-level socio-economic survey information.

CEEP's approach to estimating the potential size of a renewable energy market as follows. Consider the role of household income as a key predictor, according to the LRMs estimated above, we can infer that households whose annual incomes are equal to or above 3000 Yuan are more likely to purchase PV systems than households whose annual incomes are below 3000 Yuan (with odds ratio of yes being 2 and estimated probability of using a PV system being 0.66).

If we then look at the household income distribution in a province, it's possible to estimate the number of potential PV users. If, for example, 70% of rural, non-grid connected households living in a province have an annual income equal to or above 3000 Yuan, we would conclude that appropriately 46% of rural, non-grid connected households living in the province could be expected to be potential purchasers of a PV system (i.e., $66\% \times 70\% = 46.2\%$ of rural, non-grid connected households). By using socio-economic information from our province survey in combination with the LRM results, we can determine the potential size of the future rural market for renewable energy systems in Western China.

6.6 Future Rural Renewable Energy Market Potentials in IMAR, Qinghai and Xinjiang

Based on socio-economic data provided by the Center for Renewable Energy Development (CRED) of China,¹² together with the logistical regression models described above, CEEP estimates the market potentials of renewable energy systems in IMAR, Qinghai and Xinjiang as follows:

TABLE 6-8 : ANALYSIS OF WESTERN CHINA MARKET POTENTIAL: WILLINGNESS TO OWN AND PAY FOR RENEWABLE ENERGY SYSTEMS

	Willingness to Own				Willingness to Pay for Renewable Systems
	PV	Wind	Hybrid System	Large System	
IMAR	93.00%	95.41%	64.71%	57.57%	60.39%
Xinjiang	91.18%	78.92%	73.38%	66.18%	51.11%
Qinghai	95.19%	92.82%	70.26%	63.54%	61.55%

- The Potential for PV Systems: Our analysis suggests that in the province of IMAR, about 93% of rural, non-grid connected households would have an interest in owning a PV system, while the figure for Xinjiang and Qinghai is 92%, and 95%, respectively.
- The Potential for Wind Systems: The willingness to own a wind system is likely highest in IMAR. About 95% of rural households without access to grid electricity would have an interest in owning a wind system in IMAR, while in Xinjiang and Qinghai the willingness is 79%, and 93%, respectively.
- The Potential for Hybrid Systems: The willingness to own hybrid systems is lower in the three provinces than for stand-alone PV and wind systems. Our research suggests that in IMAR, Xinjiang and Qinghai, 65%, 73% and 70%, respectively, of rural households would express an interest in purchasing a hybrid systems.

- The Potential for Large Hybrid Systems: In IMAR, about 58% of rural households would be likely to have interest in owning a large hybrid system, while in Xinjiang, and Qinghai the willingness to own large systems is 62%, and 64%, respectively.
- Willingness To Pay: While rural households in Western China express strong preferences for renewable energy systems (either PV, wind or hybrid systems), the percentage of those willing to pay market prices is smaller than the percentage of those willing to own. This can be explained by the fact that, although there exists a sizable interest in renewable energy technology in Western China, the market is still in the early stages of development and the capacity of rural households to pay existing prices for the technology is limited. It is clear that the rural renewable energy industry, if it is to grow, needs to overcome a series of market barriers with the help of a variety of market tools. This could stimulate a more repaid opening of Western China's potential for large market.

Based upon the above estimates and using the statistical data on unelectrified rural households in the three provinces/regions (Table 2-1) for our survey, we can estimate the market size of stand-alone PV and wind systems by province/region with the following formula:

$$\text{market size} = \text{number of unelectrified rural households in each province} \times \% \text{ of willingness to own} \times \% \text{ of willingness to pay}$$

The market size of stand-alone PV and wind systems, hybrid systems, and large systems in IMAR, Xinjiang and Qinghai is presented in Table 6-9. Here, CEEP assumes that the average size of a PV system is 50 Wp, and 100 W for wind in order to calculate market potential in capacity.

¹² CRED, 1997, *Renewable Energy Survey Report in Xinjiang, Qinghai, Gansu and Inner Mongolia*.

TABLE 6-9: MARKET SIZE OF RENEWABLE ENERGY SYSTEM IN IMAR, XINJIANG AND QINGHAI

	Total Units Could Be Sold (units)				Total Capacity Could Be Sold (MW)	
	PV	Wind	Hybrid System	Large System	PV	Wind
IMAR	195,793	200,867	136,234	121,202	9.79	20.09
Xinjiang	189,990	164,444	152,900	137,898	9.50	16.44
Qinghai	58,698	57,237	43,325	39,182	2.93	5.72

A recent World Bank report -- *Assessing Markets for Renewable Energy in Rural Areas of Northwestern China* — by Tuntivate Voravate et al (1999) does an analysis of the potential market for PV systems in Northwestern China, the result is shown in Table 6-10.

TABLE 6-10: MARKET SIZE ESTIMATION OF PV SYSTEM IN IMAR, XINJIANG AND QINGHAI BY WORLD BANK

	Total Units of PV Could Be Afford (units)	
	Small	Large System
IMAR	180,186	133,348
Xinjiang	196,991	84,421
Qinghai	60,026	23,226

source: *Assessing Markets for Renewable Energy in Rural Areas of Northwestern China*, 1999

In comparison with the estimates by CEEP and World Bank, it is easily to find the market size for PV (small and large system) are very close. This also proves the correctness of market size estimation by the two organizations.

Conclusion

This chapter estimates the potential market for renewable energy systems in Western China. Many households in these areas are interested in owning renewable

energy systems and a large number are willing to pay current market prices – indeed, we suggest that there are upwards of 850,000 rural households potentially willing to purchase renewable energy systems. Their willingness to pay depends on annual household income, age and other factors. From Table 6-8 and 6-9, it is evident that the potential market for renewable energy systems in Western China is very promising. Near-term, we would expect that over 22 MW of PV and 42 MW of small-scale wind systems could be sold in the three Western provinces to rural, non-grid connected households. In the next chapter, policy options for stimulating commercialization of renewable energy systems in Western China will be discussed.

7. POLICY OPTIONS FOR STIMULATING COMMERCIALIZATION OF RENEWABLE ENERGY IN WESTERN CHINA

While this analysis demonstrates the existence of economic and reliable renewable energy applications to address rural electricity needs in Western China, there are important barriers preventing the commercialization of these decentralized technologies. Barriers ranging from high initial cost to lack of loan service can prevent the realization of the full potential of renewable energy in Western China. To remove these barriers and to take full advantage of the opportunities identified by this research, policies and institutional strategies for rural renewable energy development are needed. The policy proposals offered here seek to facilitate the development of a viable off-grid renewable energy market. Our policy proposals include: (1) building an institutional framework; (2) increasing financial support; (3) creating renewable energy markets; (4) improving services and training for the utilization of renewable energy technologies; and (5) global cooperation.

7.1 Building An Institutional Framework

China needs to build an effective institutional framework to promote renewable energy use, especially in its rural areas where conventional grid connections are not feasible. Renewable energy options should be integrated into the government's overall rural development plans. Rural electrification programs should include renewable energy technologies, especially decentralized options, as an important part of a portfolio of technologies that can provide rural people with cost-effective electricity services. China is in the process of building its economic infrastructure for the 21st century, and setting aggressive goals for renewable energy use will help to assure that social and environmental objectives are realized in concert with economic ones. Moreover, major government targets for development of rural renewable energy technologies can stimulate the use of decentralized systems in remote rural communities which continue to expect grid connections in the near future and are thus resistant to accepting renewable energy systems.

Reform of existing organizational structures in order to increase governmental coordination in rural renewable energy development would also contribute positively to a renewable energy future for China. Proposed changes include: (1) the creation of a coordinating body such as a State Renewable Energy Development Board; and (2) the expansion of the Center for Renewable Energy Development to include regional affiliates and with a mandate to organize renewable service providers at local levels.

In addition, provincial government politics could assist efforts to build a stronger infrastructure for renewable energy development. These efforts could include: (1) the adoption of specific regulatory measures to support renewable energy development; (2) establishment of sustainable development training centers to help translate sustainability principles into practice; (3) enhancement of cooperation between provincial and local governments and provincial governments and industry to facilitate renewable energy development; and (4) public campaigns and general education to popularize the use of renewable energy technologies.

7.2 Investing in Renewable Energy

China should consider the adoption of incentive policies to attract early investment in renewable energy technologies. Sliding-scale investment tax credits to manufacturers and developers and tax incentives offered to individual customers can spur early adoption of renewable energy technologies. Successful incentive programs in other countries include:

- tax credits for the first-time renewable energy system buyers;
- tax exemptions on the interest earned from renewable energy development bonds;
and
- tax deductions in interest payments for renewable energy loans.

Recognition of the social and environmental benefits of renewable energy justifies reducing tax rate on renewable energy producers and consumers. Such incentive policies can facilitate early adoption of renewable energy technologies.

In addition to incentive policies, China can examine market transformation strategies to help the market for renewable energy technologies to flourish. One important option in this vein is the establishment of renewable energy enterprise zones (REEZs). REEZs encourage investment in industrial infrastructure to spur low-cost manufacturing of renewable energy systems. A second option would be to adopt renewable energy set-asides in which provincial and local governments set specific targets to increase the use of renewable energy. Such a strategy can quickly lead energy suppliers to identify least-cost applications and stimulate focused technology development to meet emerging markets. A third option is to develop niche markets for renewable energy that can help the market grow. Governments and utilities can facilitate this development by identifying niche markets and by purchasing renewable energy systems for their own uses. Fourth, partnerships among government agencies, renewable energy manufacturers and renewable energy service providers can be promoted by government award programs and by competitive bidding for government cost-shared grants for commercial development. Finally, there is a need to support policy collaborative involving government, industry, community and research organization that can identify local renewable energy opportunities and encourage their development through policy and institutional reforms.

7.3 Increasing Financial Support

To foster self-sustaining rural renewable energy markets in Western China, greater financial services to rural users will be needed.

The commercialization of renewable energy in Western China requires the establishment of energy markets for rural populations. To nurture such a commercial market, there is a need to increase investment in renewable energy development.

Financial resources for renewables could be mobilized by issuing renewable energy development bonds, creating green energy investment funds, and using taxes on the production and use of fossil fuels.

The creation of rural renewable energy revolving funds (RERFs) as financial instruments to provide needed capital for rural renewable energy development deserves special attention. Rural households typically lack access to commercial financing and RERFs can fill the gap by marshalling public seed funds to serve as the initial source of capital. Household repayments can then be used to expand the size of the fund over time. The existence of such funds can significantly help to establish market opportunities by expanding the number of household and villages that are able to purchase renewable energy systems.

Rural financing programs should include low-interest loans provided by governments to low-income families. If low-income customers can pay less in the beginning and increase payments later when their businesses grow (or they are able to borrow money at a lower rate in the beginning years and a higher rate in later years), the twin purposes of rural economic development and electrification can both be served. Furthermore, to give customers more financing choices, the government should also explore other effective financial tools such as manufacturer financing, retailer financing, cooperative financing, as well as lease and rent-to-buy agreements.

7.4 Utilization of Renewable Energy Improving Services and Training for the Technologies

The success of commercialization efforts depends also upon its social acceptability. There is a need to improve service and maintenance arrangements for renewable energy technologies. Rural users need to be provided with adequate repair and preventive maintenance services locally. There is also a need for training consumers in basic operation skills such as correct appliance connections and battery usage, as well as in routine maintenance procedures such as filling batteries with water and cleaning PV panels or wind turbine blades. User training should also include load control skills that

can help end-users manage their daily energy uses efficiently and reduce the need for large storage requirements in renewable energy systems. Enhanced training in renewable energy applications along with increased design skills, improved quality standards of renewable energy products, and an expanded scope of renewable energy services can serve as the keys to continuing user satisfaction. This, in turn, can lead to greater market penetration of renewable energy technologies in rural areas.

7.5 Global Cooperation

Finally, China could seek capacity-building and institutional support from multilateral development organizations as well as bilateral aid and development agencies in the areas of energy planning, regulatory reform, market transformation, and policy intervention. China can take action, as well, to clearly define the institutional basis for cooperation with other countries to foster the transfer of renewable energy technologies. Furthermore, China can explore greater renewable energy development opportunities through participation in global information exchanges on energy and the environment that focus on renewables.

7.6 Conclusion

Rural electrification is now and will remain an essential element for rural development in Western China. Renewable energy technologies, such as PV, wind and hybrid systems, can provide an economical and environmentally sustainable option for meeting energy needs of rural households in Western China. Adoption of effective policies — the building of an institutional framework to support renewable energy development, the establishment of effective financial mechanism to provide capital for renewable energy development, the adoption of incentive based actions to spur renewable energy development, the implementation of market transformation strategies to encourage renewable energy development, and the enhancement of international cooperation to promote renewable energy technologies — will create the “level playing field” needed to enable renewable energy technologies to compete with conventional options such as fossil fuel.

Undoubtedly, the challenges faced by Western China are great. However, these challenges can be met if principles of sustainable development inform economic, energy and environmental policy, and if international support is mobilized to meet Western China's needs. Together, China government and the world community can produce the new ideas and enact the innovative polices that will realize a sustainable future under the framework of *Great Exploitation* of Western China.

REFERENCES

- Byrne, John, Bo Shen and William Wallace. 1998. *"The Economics of Sustainable Energy for Rural Development: A Study of Renewable Energy in Rural China."* Energy Policy, Vol. 26 (1), pp.45-54.
- Byrne, John, Bo Shen and Xiuguo Li. 1994. *"Energy Efficiency and Renewable Energy Options for China's Economic Expansion."* Proceedings of the 1994 Summer Study on Energy Efficiency in Buildings, Volume 4, pp. 25-36. Washington, DC: American Council for an Energy-Efficient Economy.
- Byrne, John, Bo Shen and Xiuguo Li. 1996. *"The Challenge of Sustainability - Balancing China's Energy, Economic and Environmental Goals."* Energy Policy, Vol. 24 (5), pp. 455-462.
- Byrne, John, Young-Doo Wang, Bo Shen and Xiuguo Li. 1994. *"Sustainable Urban Development Strategies for China,"* Environment and Urbanization, Vol.6 (1), pp. 174-187.
- Byrne, John, Young-Doo Wang, Bo Shen, Chongfang Wang, Craig Kuennen and Xiuguo Li. 1993. *"Urban Sustainability During Industrialization: The Case of China."* Bulletin of Science, Technology & Society, Volume 13 (6), pp. 324-331.
- China Rural Areas Poverty-Alleviation Investigation Report*, Poverty-Alleviation Office of State Council, World Bank, UNDP, 1999, WWW.CNSP.ORG.CN/ZTBD/FPZLYT
- China's Agenda 21—White Paper on China's Population, Environment and Development in the 21st Century*, China Environment Science Press, Beijing, P.R.China, 1994
- China Electric Power Yearbook, 1996*, Editorial Committee of China Electric Power Yearbook, Beijing: China Statistical Publishing House
- He, Dexin & Shi, Pengfei. (1995). Wind energy utilization in China. In Luguang Yan (Ed.) *Solar energy in China: Proceedings of the high-level expert Meeting for China*, p 128-136. Beijing, China: Chinese Academy of Sciences.
- Inner Mongolia Statistical Yearbook, 1997*, Beijing: China Statistical Publishing House
- Inner Mongolia Statistical Yearbook, 1999*, Beijing: China Statistical Publishing House
- Michael Parkin, *Microeconomics*, Second Edition, Addison-Wesley Publishing Company, 1993
- Ministry of Agriculture of China, *Materials on Wind and Solar Energy Resources Statistics in Western China*, 1997

Renewable Energy Survey Report in Northwestern China, 1999, Center for Renewable Energy Development, Energy Research Institute, China

Shen, Bo. (1998). *Sustainable energy for the rural developing world: The potential for renewable energy to assist developing countries in pursuing sustainable rural development*. Ph.D. Dissertation. University of Delaware.

Statistical Yearbook of China 1997. Beijing: China Statistical Publishing House.

Yan, Changle. (1996). *China Energy Development Report*. Beijing, China: Economic Management Press.

Zhu, Ruizhao. (1988). *China's Solar and Wind Resources and Utilization*. Beijing, China: Meteorology Press.

APPENDIX A: DESCRIPTION OF DATA REQUIRED TO RUN THE RURAL RENEWABLE ENERGY ANALYSIS AND DESIGN (RREAD)

Resource and Climate Data

Variable	Description
Hourly Average Global Horizontal Insolation (kWh/m ²)	Average solar insolation on a horizontal surface of a given location measured on an hourly basis for a full year (8,760 hours). If records of 8,760 hours are not available, RREAD requires values for every hour, for one typical day each month (288 records).
Hourly Wind Speed (m/s)	Site-specific wind speed measured at hub height of the wind turbine at the beginning of each hour. A multiple-year wind database is recommended to produce a full year wind profile (8,760 records).
Monthly Wind Speed Profile (m/s)	Site-specific description of the number of hours in each month that wind speeds from zero to, say, 30m/s occur (12 profiles). This database can be used in conjunction with a distribution of hourly wind speeds from a different, but comparable, site to simulate an 8,760-hour profile, if necessary.
Hourly Average Ambient Temperature (°C)	Average ambient temperature of a given location measured on an hourly basis for a full year (8,760 hours). If records of 8,760 hours are not available, RREAD requires values for every hour on one typical day each month (288 records).

Load Data

Variable	Description
Type of Appliance	The types of household appliances including CFL, fluorescent bulb, incandescent bulb, transistor radio, tape recorder, TV, VCR, electric heater, electric iron, electric fan, electric cooker, wash machine, refrigerator, air conditioner, electric pump, among others.
Number of Units	Number of units for each kind of appliance
Appliance Rated Power (W)	Rated power per unit of appliance
Daily Operating Hours (hours)	Operating time per day by month for each unit of appliance, for 12 months of an entire year (12 records).

System Configuration Data

Variable	Description
<i>PV Array</i>	
Latitude (degrees)	The latitude of the site where system is operated.
PV Array Angle (degrees)	The angle of declination from horizontal of the

	PV array.
PV Array Area (m ²)	The surface area of the PV array.
PV Module Efficiency (%)	The fraction of solar energy that the PV array is capable of converting into direct-current electricity at PTC standard conditions.
Array Lifetime (years)	The expected useful lifetime of the PV array.
<i>Wind Turbine</i>	
Hub Height (m)	Distance from the center of the wind turbine rotor to the surface terrain.
Rotor Diameter (m)	The distance across the rotor.
Turbine Power Curve (kW)	The wind turbine's generated power at varying wind speeds (taking into account the incident energy lost from the turbine).
Wind Turbine Lifetime (Years)	The expected useful lifetime of the wind turbine.

System Configuration Data (Continued)

Variable	Description
<i>Balance of System Components</i>	
Size of Battery Bank (Ah)	The storage capacity of the battery bank.
Battery Average Depth of Discharge (% of rated capacity)	The fraction of its maximum capacity that the battery is allowed to be discharged per day.
Battery Round-Trip Energy Losses (%)	The percentage of incident energy lost due to the charging and discharging of battery.
Battery Lifetime (Year)	The expected useful life of the battery bank.
Size of Charge Controllers (W)	The size of charge controller used to prevent the battery from being overused.
Lifetime of Charge Controller (Year)	The expected useful life of the charge controller.
Size of DC/AC Inverters (W)	The size of inverter used to convert direct current (DC) to alternating current (AC).
Inverter Lifetime (Year)	The expected useful life of the inverter.
Inverter Energy Losses (%)	The percentage of incident energy lost due to the conversion of DC to AC.
<i>Engine Generator</i>	
Engine Rated Power (W)	The nominal value of the generator power output.
Daily Operating Hours (Hour)	The engine's operation hours per day.
Engine Replacement Interval (Hour)	The typical replacement schedule for the engine.
Engine Overhaul Interval (Hour)	The typical repair schedule for the engine.
Fuel Consumption Rate (liter/hour)	The rate of fuel consumption by the engine.
Lube Consumption Rate (liter/hour)	The rate of lubricating oil consumption by the engine.

Cost Data

Variable	Description
PV System Costs (\$)	The initial capital cost of the PV array plus system delivery cost, installation cost and warranty.
Wind System Costs (\$)	The initial capital cost of the wind turbine plus system delivery cost, installation cost and warranty.
Engine Gen-Set Costs (\$)	The capital cost of the engine generator plus system delivery cost, installation cost and warranty.
PV Module Replacement Cost (\$)	The cost of replacing a PV array over its lifetime.

Wind Turbine Replacement Cost (\$)	The cost of replacing wind turbine over its lifetime.
Engine Generator Overhaul Cost (\$)	The cost of repairing the engine at each overhaul interval.
Engine Generator Replacement Cost (\$)	The cost of replacing generator over its lifetime.
PV Array Scrap Value (\$)	The salvage value of the PV array beyond its lifetime.
Wind Turbine Scrap Value (\$)	The salvage value of the wind turbine beyond its lifetime.
Engine Generator Scrap Value (\$)	The salvage value of the generator beyond its lifetime.
Annual Operation & Maintenance (O&M) Costs (\$)	Annual cost of removing dust and film from the PV array surface, of minor repairs and scheduled refurbishment of the wind turbine, of lubrication and bushing repairs for engine generator, and of electrical connection inspection and scheduled maintenance for BOS components.
Fuel Cost (\$/liter)	The unit price of fuel in the local market.
Lube Cost (\$/liter)	The unit price of lube oil in the local market.
Fuel Delivery Cost (\$/liter)	The unit cost of delivering fuel to the site where fuel is consumed.
Lube Delivery Cost (\$/liter)	The unit cost of delivering lube oil to the site where consumed.

Cost Data (Continued)

Variable	Description
Battery Costs (\$)	Retail prices of batteries. A price matrix for locally available batteries is preferred.
Controller Costs (\$)	Retail prices of charge controllers. A price matrix for locally available controllers is preferred.
Inverter Costs (\$)	Retail prices of DC/AC inverters. A price matrix for locally available inverters is preferred.

Financial Data

Variable	Description
Discount Rate (%)	The interest rate used to determine the present worth of a future value.
Evaluation Period (Year)	The number of years for which a future value is discounted to its present value.
Currency Exchange Rate	The conversion rate between foreign exchange and domestic currency.
Tariff (%)	A duty imposed on an imported part.

Policy Data

Variable	Description
Subsidy (\$)	A direct transfer payment made by a government to a manufacturer or a customer.
Rebate (\$)	A direct cash payment made by a manufacturer to a customer.

Fossil Fuel Tax (\$/liter)	An energy tax imposed by a governmental authority upon the use of per unit of fossil fuels.
Land Use Charge (\$)	A toll charge imposed by local authority upon the use of local lands for activities such as transporting fuels.

APPENDIX B: HOUSEHOLD SURVEY TEMPLATE FOR RURAL ENERGY USE IN WESTERN CHINA

Household Profile

Part 1 Address of Interviewee

Household Number:

Zip Code:

Province:

Name of MOA Interviewer:

County/City:

Date of Interview:

Village/Town:

Part 2 General Information about the Household

1.1 Name of Respondent:

1.2 Sex of Respondent:

1.3 Age of Respondent:

1.4 Education Level of Respondent:

- [1] Never attended school
- [2] Attended primary school
- [3] Attended junior middle school
- [4] Attended senior middle school
- [5] Vocational School
- [6] College level or above

1.5 Occupation of Respondent:

- [1] Worker
- [2] Farmer
- [3] Teacher
- [4] Business
- [5] Administrative Personnel
- [6] Other (specify)

If the respondent is not the household head, please fill out this section.

1.6 Name of Household Head:

1.7 Sex of Household Head:

1.8 Age of Household Head:

1.9 Education Level of Household Head:

- [1] Never attended school
- [2] Attended primary school
- [3] Attended junior middle school
- [4] Attended senior middle school
- [5] Vocational School
- [6] College level or above

1.10 Occupation of Household Head:

- [1] Worker
- [2] Farmer
- [3] Teacher
- [4] Business
- [5] Administrative Personnel
- [6] Other (specify)

1.11 Respondent's Relationship to Head of the Household is:

- [1] Head of the Household
- [2] Wife or Husband of the Head
- [3] Daughter of the Head
- [4] Son of the Head
- [5] Daughter-in-law of the Head
- [6] Son-in-law of the Head
- [7] Other (specify)

1.12 How many people are in the household?

(Fill in according to age.)

0 - 6 years: Persons

7 - 17 years: Persons
 18 – 60 years: Persons
 61 years & over: Persons
 Total: Persons

1.13 Amount and Sources of Annual income of the family:

Agricultural: Yuan
 Non-agricultural: Yuan
 Total: Yuan

1.14 Annual expenditure of the family:

1.14.1 Agricultural expenditure: Yuan
 1.14.2 Non-agricultural expenditure (Total): Yuan
 [1] Food: Yuan
 [2] Electric appliances: Yuan
 [3] Transportation Equipment and Maintenance: Yuan
 [4] Water: Yuan
 [5] Electricity: Yuan
 [6] Fuel: Yuan
 [7] Education and Entertainment: Yuan
 [8] Others (Specify): Yuan
 1.14.3 Total Annual Expenditure: Yuan

1.15 Area of the house: m²

1.16 How do you heat the house?

- [1] No heating system
- [2] Stand-alone steam heating
- [3] Small scale centralized heating
- [4] Electric heating stove
- [5] Use coal, charcoal, or fuelwood
- [6] Other (specify)

1.17 What types of fuels do you use for cooking?

- [1] Coal and/or Charcoal
- [2] Straw and/or Dung
- [3] Electricity
- [4] Gas
- [5] Other (specify)

1.18 Do you have an air-conditioning system? (yes or no)

1.19.1 What did you use for lighting, previously?

1.19.2 What do you use for lighting, currently?

- [1] Electricity
- [2] Kerosene
- [3] Dry Cell Battery
- [4] Candle
- [5] Other (specify)

Information on Household Electricity and Fuel Uses

Part 1: General Information

2.1 Do you use electricity (yes or no)?

2.2 What is your source of electricity?

[1] Grid

[2] Own generation

2.2.1 What kind of generator are you using, if your electricity is self-generated?

[1] Diesel/Gasoline generator

[2] Wind turbine only

[3] PV

[4] PV/wind hybrid

[5] Others (specify)

2.3 Do you have any possibilities of being connected to the grid in the near future (yes or no)?

2.4 How much money for you to connect to the grid? Yuan

[If the household does not know, MOA staff should find out this information]

2.5 How far is the household from the nearest grid? Km

[If the household does not know, MOA staff should find out this information]

2.6 Monthly electricity and fuel consumption

Type	Amount per month	Total cost per month
Electricity	KWh	Yuan
Coal	Kg	Yuan
Firewood	Kg	Yuan
Charcoal	Kg	Yuan
Kerosene	Liter	Yuan
Diesel	Liter	Yuan
Gasoline	Liter	Yuan
LPG/LNG	Liter	Yuan
Straw/Dung	Kg	Yuan
Sawdust	Kg	Yuan
Rice Husk	Kg	Yuan
Others(fuel name:)	Unit()	Yuan
Others(fuel name:)	Unit()	Yuan

Part 2: Energy Consumption by Functional Equipment

2.7 Food Preparation Equipment

Type of Equipment	Manufacturer	Power or Size	Model Year	Fuel Type	Operating hour/day
Stove 1					
Stove 2					
Heater 1					
Heater 2					
Electric Kettle 1					
Electric Kettle 2					
Rice cooker 1					
Rice cooker 2					
Oven 1					
Oven 2					
Others(name:)					
Others(name:)					

2.8 Lighting

Type of Appliance	Manufacturer	Power or Size	Model Year	Fuel Type	Operating hour/day
Fluorescent Tube 1					
Fluorescent Tube 2					
Fluorescent Tube 3					
Fluorescent Tube 4					
Incandescent 1					
Incandescent 2					
Incandescent 3					
Incandescent 4					
CFL 1					
CFL 2					
CFL 3					
CFL 4					
Kerosene Lamp 1					
Kerosene Lamp 2					
Kerosene Lamp 3					
Kerosene Lamp 4					
Emergency Light 1					
Emergency Light 2					
Candle					
Others(name:)					
Others(name:)					

2.9 Refrigeration and cooling

Type of Appliance	Manufacturer	Power or Size	Model Year	Fuel Type	Operating hour/day
Refrigerator 1					
Refrigerator 2					
Freezer 1					
Freezer 2					
Air Conditioner 1					
Air Conditioner 2					
Electric Fan 1					
Electric Fan 2					
Others(name:)					
Others(name:)					

2.10 Household appliances

Type of Appliance	Manufacturer	Power or Size	Model Year	Fuel Type	Operating hour/day
Radio 1					
Radio 2					
Tape Recorder/Stereo 1					
Tape Recorder/Stereo 2					
Black & White TV 1					
Black & White TV 2					
Color TV 1					
Color TV 2					
VCR 1					
VCR 2					
Computer 1					
Computer 2					
Fax Machine 1					
Fax Machine 2					
Iron 1					
Iron 2					
Washing Machine 1					
Washing Machine 2					
Dish Washer 1					
Dish Washer 2					
Water Pump 1					
Water Pump 2					
Hair Drier 1					
Hair Drier 2					
Elec. Scissors/Shears					
Others(name:)					
Others(name:)					

2.11 Other equipment

Type of Equipment	Manufacturer	Power or Size	Model Year	Fuel Type	Operating hour/day
Car					
Truck					
Motor cycle					
Tractor 1					
Tractor 2					
Milling Machine 1					
Milling Machine 2					
Others(name:)					
Others(name:)					

Part 3: Future Energy Load Growth

2.12 Do you plan to buy new electric appliances in the near future (yes or no)?

2.12a If yes, specify types and Sizes of required appliances

Type of Electric Appliance	Size of Electric Appliance
	W
	W
	W
	W
	W
	W
	W

2.13 How much electricity do you need in each month in the next five years?

Year	Monthly Amount
1	kWh
2	kWh
3	kWh
4	kWh
5	kWh

Information on Household Energy Systems

Part 1 Diesel/Gasoline generator

3.1 If the household is using a Diesel/Gasoline generator, please fill out the following items.

- | | |
|--|-----------|
| [1] Fuel Type (Diesel or Gasoline): | |
| [2] Engine Size: | W |
| [3] Operating Hours Per Day: | hrs/day |
| [4] System Capital Costs: | Yuan |
| [5] Generator Lifetime: | Years |
| [6] Generator Cost: | Yuan |
| [7] Annual Maintenance and Repair Cost: | Yuan/year |
| [8] Fuel Consumption: | kg/hr |
| [9] Lube Consumption: | kg/hr |
| [10] Fuel Unit Cost: | Yuan/kg |
| [11] Fuel Transport Cost: | Yuan/kg |
| [12] Lube Unit Cost: | Yuan/kg |
| [13] Lube Transport Cost: | Yuan/kg |
| [14] Do you have troubles using this system (yes or no)? | |

Part 2 Wind System

3.2 If the household is using a wind turbine or a PV/wind hybrid system, please fill out the following items.

- | | |
|--|-----------|
| [1] Wind Turbine Manufacturer: | |
| [2] Turbine Rated Power: | W |
| [3] Hub Height: | m |
| [4] Rotor Diameter (m) / Swept Area (m ²) | l/m |
| [5] System Power Losses: | % |
| [6] System Capital Costs: | Yuan |
| [7] Turbine Lifetime: | Years |
| [8] Turbine Cost: | Yuan |
| [9] Turbine Salvage Value: | Yuan |
| [10] Annual Maintenance and Repair Cost: | Yuan/year |
| [11] Do you have troubles using this system (yes or no)? | |

Part 3 PV System

3.3 If the household is using a PV system or a PV/wind hybrid, please fill out the following items.

- | | |
|--|----------------|
| [1] PV Module Manufacturer: | |
| [2] Cell Type: | |
| [3] Module Rated Power: | Wp |
| [4] Module Area: | m ² |
| [5] Array Angle: | radians |
| [6] Module Efficiency: | % |
| [7] System Capital Costs: | Yuan |
| [8] Module Lifetime: | Years |
| [9] Module Unit Price: | Yuan/Wp |
| [10] Salvage Value of the Module: | Yuan |
| [11] Annual Maintenance and Repair Cost: | Yuan/year |
| [12] Do you have troubles using this system (yes or no)? | |

Part 4 Balance-of-System (BOS) Equipment

3.4 If your system is equipped with batteries, inverters or/and controllers, please fill out the following items.

- [1] Battery Manufacturer:
- [2] Battery Model:
- [3] Battery Type:
- [4] Number of Batteries:
- [5] Battery Voltage: V
- [6] Battery Capacity: Ampere-hours
- [7] Battery Depth of Discharge: %
- [8] Battery Lifetime: Years
- [9] Battery Cost: Yuan/battery
- [10] Inverter Size: kW
- [11] Inverter Lifetime: Years
- [12] Inverter Cost: Yuan/inverter
- [13] Controller Size: kW
- [14] Controller Lifetime: Years
- [15] Controller Cost: Yuan
- [16] Power Losses from BOS Equipment: %
- [17] Do you have troubles using this equipment (yes or no)?

Household Attitudes

Part 1. Your Views on Energy Options

4.1 Please give your view to the following energy types.

Using the numbers 1 through 4 to rank your choice. "1" indicates the best, and "4" the worst.

Type	Cost	Availability	Reliability	Convenience	Cleanliness	Safety	Overall View
Electricity from grid							
Electricity from PV-wind hybrid							
Electricity from wind							
Electricity from PV							
Electricity from gen-set							
Coal							
Natural gas							
Kerosene/Diesel							
Fuel wood/Charcoal							
Straw/Dung							

4.2 Which of the following stand-alone systems do you have a desire to buy and why?

Using the numbers 1 through 4 to rank your choice. "1" indicates the best, and "4" the worst.

Type	Your Desirability	Reliability	Price
Wind power			
PV power			
PV/Wind Hybrid			
Diesel/Gasoline generator			

4.3 Benefits of electricity

Category	Yes	No
Economic benefits		
Convenience		
Entertainment (watching TV, etc.)		
Information and education		
Cleanliness		
Safety improvement		

4.4 Advantages of using electricity generated from renewable energy

Category	Yes	No
Reliability		
Lower Cost		
Easier maintenance		
Flexibility (self-control)		
Cleanliness		
Safety and Health improvement		

Part 2. Demand Side Management

4.5 Do you think your energy expense (fuel and/or electricity) is:

- [1] very expensive
- [2] expensive
- [3] fair
- [4] cheap
- [5] I do not pay for fuel

4.6 If your energy expense is high, what are the reasons?

- [1] Overconsumption of energy
- [2] High fuel cost (fuel: _____ cost: Yuan/kg)
- [3] High electricity cost (cost: Yuan/kWh)
- [4] Other reasons (reason:)

4.7 How do you rate the quality of the electricity supply, if you have?

- [1] Very satisfied
- [2] Satisfied
- [3] Acceptable
- [4] Not satisfied due to frequent blackout and unstable electricity voltage
- [5] I do not care

4.8 If the electricity supply is of bad quality, do you experience:

- [1] economic losses from electricity blackout
- [2] appliance damage from unstable voltage
- [3] Both of above

4.9 Have you ever adopted energy saving measures (yes or no)?

4.10 Are you willing to take actions to reduce your electricity consumption,
If the actions are not difficult and are not too costly (yes or no)?

4.11 When you buy electric appliances, what features do you care most?

- [1] Brand
- [2] Price
- [3] Function
- [4] Low Electricity Consumption
- [5] Other (specify:)

Part 3. Affordability and Willingness to Pay for Renewable Energy Systems

4.12 Would you be willing to pay more for electricity if more reliable service will be provided (yes or no)?

4.13 Type of system you would like to buy in the near future:

- [1] <100W Wind
- [2] 100W-200W Wind
- [3] 200W-300W Wind
- [4] >300W Wind
- [5] <50W PV
- [6] 50W-100W PV
- [7] >100W PV
- [8] Small PV/Wind Hybrid (<100W PV and <100W Wind)
- [9] Large PV/Wind Hybrid (>100W PV and >100W Wind)
- [10] Gasoline/Diesel Generator

4.14 How much are You able to pay for a renewable energy system?

- [1] Less than 3000 Yuan
- [2] 3001 - 5000 Yuan
- [3] 5001 - 10000 Yuan
- [4] 10001 - 15000 Yuan
- [5] 15001 - 20000 Yuan
- [6] More than 20000 Yuan

4.15 How much are you willing to pay for a renewable energy system?

- [1] Less than 3000 Yuan
- [2] 3001 - 5000 Yuan
- [3] 5001 - 10000 Yuan
- [4] 10001 - 15000 Yuan
- [5] 15001 - 20000 Yuan
- [6] More than 20000 Yuan

4.16 How much are you willing to pay with a possible loan?

- [1] Less than 3000 Yuan
- [2] 3001 - 5000 Yuan
- [3] 5001 - 10000 Yuan
- [4] 10001 - 15000 Yuan
- [5] 15001 - 20000 Yuan
- [6] More than 20000 Yuan

4.17 How would you like to pay for the renewable energy system?

- [1] Lm Sum
- [2] Two Payments
- [3] Three Payments
- [4] Leasing (Pay a Monthly Fee)

Part 4. Factors Concerning the Use of Renewables

4.18 Which factors do you care the most when purchasing a renewable energy system?

- [1] Capital Cost
- [2] Quality
- [3] After-Sale Service
- [4] Capacity

4.19 What are your biggest concerns of using a renewable energy system?

- [1] Maintenance
- [2] Parts
- [3] Repair and Services

4.20 What kind of equipment that you have experienced with major problems?

- [1] Wind Turbine
- [2] PV
- [3] Battery
- [4] Controller
- [5] Inverter
- [6] Gasoline or Diesel Generator

APPENDIX C: TEMPLATE FOR SOCIO-ECONOMIC ASSESSMENT SURVEY AT COUNTY AND PROVINCIAL LEVEL IN WESTERN CHINA

1. GENERAL INFORMATION

- 1 Name of Banner:
- 2 Total Area: km²
- 3 Latitude:
- 4 Longitude:
- 5 Total Population:
- 6 Total Households:
- 7 Herdsman Population:
- 8 Herdsman Households:
- 9 Households Without Electricity Grid:

2. ECONOMIC AND FINANCIAL DATA

		Value in 1996 (Yuan)	Value in 1997 (Yuan)
10	Total Production		
11	Production from Husbandry		
12	Per Capita Income		

3. HOUSEHOLD DISTRIBUTION ACCORDING TO INCOME LEVEL

- 13 Average Income Level per Household in 1996: Yuan
- 14 Average Income Level per Household in 1997: Yuan
- 15 Total number of Households in 1997:

	Annual Income Level in 1997 (Yuan)	Number of Households	Percentage (%)
16	> 50000		
	20000 – 50000		
	10000 – 20000		
	< 10000		

4. DISTRIBUTION OF HOUSEHOLDS ACCORDING TO THEIR SHEEP

	Number of Sheep Owned in 1997	Number of Households	Percentage (%)
17	> 1000		
	600 – 1000		
	400 – 600		
	< 400		

5. DISTRIBUTION OF UNELECTRIFIED TOWNSHIPS, VILLAGES AND HOUSEHOLDS

		Total Number	Un-electrified	To be Electrified by Grid
18	Townships			
19	Villages			
20	Households			

6. APPLICATION STATUS OF WIND TURBINE AND PV SYSTEMS

- 21 Total number of households which have had wind turbine:
- 22 The number of households which have had 300W wind turbine:
- 23 The number of households which have had 200W wind turbine:
- 24 The number of households which have had 100W wind turbine:
- 25 Total number of households which have had PV systems:
- 26 The number of households have had PV system larger than 50W:
- 27 The number of households have had PV system less than 50W:

7. NUMBER OF HOUSEHOLDS INTENDING TO UPGRADE THEIR SYSTEM

- 28 Total number of households which have had wind turbine or PV systems:
- 29 The number of households who want to upgrade their system within 1 year:
- 30 The number of households who want to upgrade their system within 2 year:
- 31 The number of households who want to upgrade their system within 3 year:
- 32 The number of households who want to upgrade their system within 4 year:

8. CURRENT PRICE OF WIND TURBINE AND PV SYSTEM

Retail Price

- 33 100W wind turbine: Yuan/set
- 34 200W wind turbine: Yuan/set
- 35 300W wind turbine: Yuan/set
- 36 Single-Si solar module: Yuan/Wp
- 37 Poly-Si solar module: Yuan/Wp
- 38 a-Si solar module: Yuan/Wp

9. SUBSIDIES AND PRIORITY

- 39 Subsidy for a 100W wind turbine: Yuan/set
- 40 Subsidy for a 200W wind turbine: Yuan/set
- 41 Subsidy for a 300W wind turbine: Yuan/set
- 42 Subsidy for PV modules: Yuan/Wp
- 43 Subsidy for 16 Wp PV system: Yuan/set
- 44 Other priorities:

10. INFORMATION OF SERVICE STATION AND DEALERSHIP

(Questions answered by station personnel and dealers)

- 45 Total number of new energy service stations:
- 46 Total number of renewable energy dealers:
- 47 Sale volumes in 1995: Yuan
- 48 Sale volumes in 1996: Yuan
- 49 Sale volumes in 1997: Yuan

50	Sold Wind Turbine and PV Systems	1995	1996	1997
	300W wind turbine (set)			
	200W wind turbine (set)			
	100W wind turbine (set)			
	<50W PV			
	50W-100W PV			
	>100W PV			
	Battery			

51 Where do you get products?

- [1]Manufacturer
- [2]Wholesalers
- [3]Others (specify:)

52 How do you obtain your products?

- [1]Bidding
- [2]Placing order
- [3]Others (specify:)

53 Do you test the products (yes or no)?

54 Do you provide any warranty services (yes or no)?

55 If providing warranty, what length of warranty do you typically provide?

- [1]Less than 6 months
- [2]6 months - 1yr
- [3]More than 1 yr

56 Which components have been complained about the most by customers? (please give your ranking)

Category	Rank
PV panel	
Wind turbine	
Battery	
Inverter	
Controller	

57 How do you find your customers?

- [1]Direct marketing
- [2]Advertising
- [3]Others (specify)

58 How often do you visit your customers after a system is sold?

[1]Less that once a year

[2]Twice a year

[3]More than twice a year

59 Do you train the users and, if yes, how?

[1]We offer training classes

[2]We offer site training

[3]We provide written materials

Note: Data should be collected at both provincial/regional and county level by selected survey officers.
